

- Aluminum Electrolytic Capacitors
- Aluminum Electrolytic Capacitors with Hybrid Conductive Polymer

Aluminum
Electrolytic
Capacitors

EP-cap



Aluminum Electrolytic Capacitors

Aluminum Electrolytic Capacitors with Hybrid Conductive Polymer

EP-cap

PRECAUTIONS

- The contents of this catalog are current as of May 2009. They may change without prior notice. When ordering products, please be sure to request a delivery specifications form and read it carefully.
- Products described herein are not intended for applications requiring extremely high reliability (for example, those in which extensive human injury or property damage may occur such as with life-support systems or aircraft control systems). For such applications, consult our sales department.
- The performance, characteristics, and features of the products described in this catalog are based on the products working alone under prescribed conditions. Data listed here is not intended as a guarantee of performance when working as part of any other product or device. In order to detect problems and situations that cannot be predicted beforehand by evaluation of supplied data, please always perform necessary performance evaluations with these devices as part of the product that they will be used in.
- When using the products listed in this catalog, please always be sure to try to prevent any possible accidents or injury by designing products in a careful and safe manner. If you have any questions concerning the use of these products, please contact any of our sales representatives.
- For any products listed in this catalog that may constitute restricted trade goods under overseas exchange or service trade laws, permission to deliver according to law may be required before importing.
- Unauthorized duplication of this catalog in part or in whole is forbidden.
- Please understand that we cannot be held responsible for any damages to the industrial properties of any third party that arise from the use or application of the products listed in this catalog, with the exception of those items directly related to method of construction.

INDEX

Aluminum Electrolytic Capacitors 2

Series System Diagram	3
Product Line-up Table	5
Guidelines and Precautions for Use	7
Environmental Consideration / Surface Mount Type Recommended Land Pattern	11
Soldering Condition / Recommended Reflow Condition ..	12
Packing Specifications	13
Ripple Current Frequency Coefficient	16
Anti-vibration Structure	17
■ Aluminum Electrolytic Type / Surface Mount Type ..	18
■ Aluminum Electrolytic Type / Radial Lead Type	48

Aluminum Electrolytic Capacitors with Hybrid Conductive Polymer 78

■ About EP-cap	
Soldering Condition / Recommended Reflow Condition / Ripple Current Frequency Coefficient	79
■ Hybrid Conductive Polymer Type / Surface Mount Type ..	80



Aluminum Electrolytic Capacitors is hard to be in Short-mode because, it has Shelf-healing mechanism at the dielectric layer by its electrolyte. Aluminum Electrolytic Capacitors supply wide range of capacitance and voltage. They are suitable for economical circuit design.

Features

Wide rated voltage range from 4.0V to 400V

Wide capacitance range from 0.1 μ F to 82000 μ F

Self healing of the dielectrics (aluminium oxide film) after damages.

The main failure mode is of wear-out. Short circuit within capacitor is not appreciable.

No voltage dependence of capacitance.

Can withstand applied pulse current and pulse voltage compared to other types of capacitors.

Applications

Automotive electric, Network equipment, Industrial equipment, Digital equipment, Consumer equipment, PC etc.

Series integration

On new order, please order from Integrated series.

Discontinued series	Integrated series	Feature
CE-GS	CE-GA	Surface mount type, 5.4mm height, low impedance
CE-GX	CE-AX	Surface mount type, low impedance, high-reliability
CE-FC	CE-FD	Surface mount type, 4.5mm height
CE-PX	CE-PC	Surface mount type, 125°C Long life

Discontinued series	Integrated series	Feature
MV-AZ	ME-CZ	105°C Standard
MV(ME)-FA	ME-CZ	105°C Standard
MV-EG, GX	ME-AX	105°C low impedance, high-reliability
MV-HW	ME-HC	85°C Standard
MV-HPS	ME-HPC	85°C Miniature, standard (mid.&high voltage)
MV-NPD, NPDW	ME-HWN	85°C Bi-polar (miniature, standard)

INDEX

■ About the Aluminum Electrolytic Capacitors

Series System Diagram	3
Product Line-up Table	5
Guidelines and Precautions for Use	7
Environmental Consideration / Surface Mount Type Recommended Land Pattern	11
Soldering Condition / Recommended Reflow Condition	12
Packing Specifications	13
Ripple Current Frequency Coefficient	16
Anti-vibration Structure	17

■ Aluminum

Electrolytic Type	
Surface Mount Type	
CE-BJ Series	18
CE-BE Series	19
CE-BD Series	20
CE-BSS Series	21
CE-C Series	22
CE-BS Series	23
CE-FE Series	24
CE-FD Series	25
CE-LD Series	26
CE-FSS Series	27
CE-FS Series	28

CE-FH Series	31
CE-GA Series	32
CE-AX Series	33
CE-KX Series	35
CE-LX Series	37
CE-LS Series	39
CE-LH Series	40
CE-LL Series	42
CE-PC Series	43
CE-PH Series	45
CE-NP Series	46
CE-FN Series	47



Radial Lead Type

ME-UW Series	48
ME-SWB Series	49
ME-HC Series	50
ME-HPC-HPD Series	51
ME-UZ-SZ Series	52
ME-CZ Series	53
ME-UAX-SAX Series	55
ME-LS Series	56
ME-CA Series	57
ME-CX Series	59
ME-AX Series	61
ME-WX Series	63
ME-WA Series	65

ME-WL Series	67
MB-UWG Series	68
ME-SWG Series	69
ME-WG Series	70
ME-PX Series	71
ME-FC-FD Series	73
ME-FAZ Series	74
ME-FH Series	75
ME-SWN Series	76
ME-HWN Series	77

Product Line-up Table

Product Line-up Table of Aluminum Electrolytic Capacitors with Hybrid Semiconductor

Classification	Series	Page	Features	Small & Thin type	Low ESR	Long Life	Solvent Proof	Category Temperature Range(°C)	Rated Voltage Range(V.DC)	Rated Capacitance Range(μF)	External Appearance	Marking Color	
S.M.T		CE-EX	80	Super Low ESR		●		●	-55 to +105	4.0 to 10	22to820	—	Green
		NEW H V H	81	Super Low ESR		●	●	●	-55 to +105	25 to 63	2.7to270	—	Blue
		NEW H V P	82	125°C		●	●	●	-55 to +125	25 to 63	3.9to270	—	Blue

Product Line-up Table of Surface Mount Type

Classification	Series	Page	Features	Small & Thin type	Low Impedance	Long Life	Solvent Proof	Category Temperature Range(°C)	Rated Voltage Range(V.DC)	Rated Capacitance Range(μF)	External Appearance	Marking Color		
Surface Mount Type		CE-BJ	18	Super Low Profile 3.25mm Height	●			●	-40 to +85	4.0 to 50	10to82	—	Black	
		CE-BE	19	Super Low Profile 3.9mm Height	●			●	-40 to +85	4.0 to 50	1.0to180	—	Black	
		CE-BD	20	Low Profile 4.5mm Height	●			●	-40 to +85	4.0 to 50	0.1to220	—	Black	
		CE-BSS	21	Miniature, Standard	●			●	-40 to +85	6.3 to 50	4.7to220	—	Black	
		CE-C	22	φ 3mm Version	●			●	-40 to +85	4.0 to 50	0.1to22	—	Black	
		CE-BS	23	Standard				●	-40 to +85	4.0 to 100	0.1to6800	—	Black	
		CE-FE	24	3.9mm Height Temperature of Wide Range	●			●	-40 to +105	6.3 to 50	1.0to100	—	Black	
		CE-FD	25	4.5mm Height Temperature of Wide Range	●			●	-40 to +105	6.3 to 50	0.1to100	—	Black	
		CE-LD	26	4.5mm Height Long Life	●		●	●	-40 to +105	6.3 to 50	0.1to100	—	Black	
		NEW CE-FSS	27	105°C Miniature Hi-Capacitance	●			●	-40 to +105	6.3 to 50	4.7to220	—	Black	
		CE-FS	28	105°C, Standard					●	-40 to +105	160 to 400	2.2to82	—	Black
			29					●	-55 to +105	6.3 to 63	0.1to6800			
							●	-40 to +105	100	1.0to150				
		CE-FH	31	Long Life			●	●	-40 to +105	6.3 to 50	0.1to4700	—	Black	
		CE-GA	32	5.4mm Height Super Low Impedance		●		●	-55 to +105	6.3 to 63	0.47to100	—	Black	
		CE-AX	33	Low Impedance, High-Reliability		●		●	-55 to +105	6.3 to 50	4.7to6800	—	Black	
		CE-KX	35	Super Low Impedance		●		●	-55 to +105	6.3 to 100	4.7to6800	—	Black	
		CE-LX	37	Low Impedance, Long Life		●		●	-55 to +105	6.3 to 100	4.7to6800	—	Black	
		CE-LS	39	Low Impedance, Long Life		●	●	●	-40 to +105	6.3 to 50	10to330	—	Black	
		CE-LH	40	Long Life				●	●	-40 to +105	6.3 to 50	0.1to220	—	Black
41					●		-40 to +105	160 to 400	2.2to82					
NEW CE-LL	42	Low Impedance, Long Life		●	●	●	-25 to +105	6.3 to 50	10to1000	—	Black			
CE-PC	43	125°C, Long Life				●	●	-55 to +125	6.3 to 100	1.0to4700	—	Black		
CE-PX	※	125°C				●	●	-40 to +125	6.3 to 50	33to1500	—	Black		
CE-PH	45	125°C Low Impedance, Hi-Capacitance		●	●	●	-40 to +125	16 to 35	160to1500	—	Black			
CE-NP	46	Bi-polar					●	-40 to +85	6.3 to 50	0.1to47	—	Black		
CE-FN	47	Bi-polar Temperature of Wide Range					●	-55 to +105	6.3 to 63	0.1to47	—	Black		

Product Line-up Table of Radial Lead Type

Classification	Series	Page	Features	Small & Thin type	Low Impedance	Long Life	Solvent Proof	Category Temperature Range(°C)	Rated Voltage Range(V.DC)	Rated Capacitance Range(μF)	External Appearance	Marking Color		
Radial Lead Type		ME-UW	48	5mm Height	●			●	-40 to +85	4.0 to 50	10to330	Black	White	
		ME-SWB	49	7mm Height	●			●	-40 to +85	4.0 to 63	0.1to470	Black	White	
		ME-HC	50	Standard	●			●	-40 to +85	6.3 to 100	0.1to15000	Black	White	
		ME-HPC	51	Miniature, Standard (Mid. & High Voltage)		●				-40 to +85	160 to 250	0.47to220	Black	White
									-25 to +85	350 to 450	0.47to100			
ME-HPD	51	Miniature, Low Profile (Mid. & High Voltage)		●				-40 to +85	160 to 250	47to220	Black	White		
							-25 to +85	350 to 450	10to68					

Product Line-up Table

Product Line-up Table of Radial Lead Type

Classification	Series	Page	Features	Small & Thin type	Low Impedance	Long Life	Solvent Proof	Category Temperature Range(°C)	Rated Voltage Range(V.DC)	Rated Capacitance Range(μF)	External Appearance	Marking Color
				●	●	●	●					
Radial Lead Type 	ME-UZ	52	5mm Height, Temperature of Wide Range	●			●	-55 to +105	6.3 to 50	10to220	Green	White
	ME-SZ	52	7mm Height, Temperature of Wide Range	●			●	-55 to +105	6.3 to 50	0.1 to 330	Green	White
	ME-CZ	53	Miniature, Standard Temperature of Wide Range	●			●	-55 to +105	6.3 to 100	0.1 to 15000	Green	White
	ME-UAX	55	5mm Height, Low Impedance	●	●		●	-55 to +105	6.3 to 35	33to220	Green	Gold
	ME-SAX	55	7mm Height, Low Impedance	●	●		●	-55 to +105	6.3 to 35	4.7to330	Green	Gold
	ME-LS	56	Long Life, High-Reliability		●	●	●	-40 to +105	6.3 to 50	1.0to1000	Black	Silver
	ME-CA	57	Miniature, Standard Low Impedance	●	●		●	-55 to +105	6.3 to 50	0.47to15000	Green	Silver
	ME-CX	59	Miniature, Low Impedance	●	●		●	-55 to +105	6.3 to 35	47to15000	Green	Gold
	ME-AX	61	Low Impedance, High-Reliability		●	●	●	-55 to +105 -40 to +105	6.3 to 63 100	0.47to12000 5.6to470	Green	Gold
	ME-WX	63	Low Impedance·High Ripple		●			-40 to +105	6.3 to 50	22to6800	Green	Gold
	ME-WA	65	Low Impedance · High Ripple Long Life		●	●		-40 to +105	6.3 to 35	220to8200	Black	Gold
	NEW ME-WL	67	Low Impedance Long Life	●	●	●		-40 to +105	6.3 to 63	1.0to330	Green	Silver
	MB-UWG	68	5mm Height, Low ESR	●	●			-40 to +105	6.3 to 25	39to150	—	Black
	ME-SWG	69	7mm Height, Low ESR	●	●			-40 to +105	6.3 to 35	22to330	Black	Gold
	ME-WG	70	Super Low ESR		●			-40 to +105	6.3 to 25	220to3300	Green	Gold
	ME-FZ	※	Extra Long Life, High Performance		●	●	●	-55 to +105	10 to 50	10to4700	Black	Silver
	ME-PX	71	125°C, High Performance		●	●	●	-55 to +125	10 to 100	1.0to4700	Clear Green	Black
		72			●		-40 to +125	160 to 250	10to150			
				●		-25 to +125	350 to 400	4.7to47				
	ME-FC	73	Miniature, Guaranteed 105°C (Mid. & High Voltage)	●				-40 to +105	160 to 400	0.47to220	Black	White
							-25 to +105	450	1.0to47			
ME-FD	73	105°C, Miniature, Low Profile (Mid. & High Voltage)	●				-40 to +105	160 to 400	22to220	Black	White	
							-25 to +105	450	10to33			
ME-FAZ	74	High Ripple(Mid.Voltage)		●			-40 to +105	160 to 250	1.0to220	Black	White	
ME-FH	75	105°C, Long Life (Mid. & High Voltage)			●		-40 to +105	160 to 400	10to220	Black	White	
							-25 to +105	450	6.8to47			
ME-HLB	※	Low Leakage Current					-40 to +85	16 to 50	0.1 to 100	Blue	Black	
ME-HT	※	Timer Circuit Use					-40 to +85	10 to 50	1.0to2200	Green	Black	
ME-SWN	76	7mm Height, Bi-polar	●			●	-40 to +85	6.3 to 50	0.1 to 47	Black	White	
ME-HWN	77	Miniature, Standard, Bi-polar	●			●	-40 to +85	6.3 to 100	0.47to2200	Black	White	

Please refer to <http://www.sunelec.co.jp> for the information in columns where ※ marking is indicated in a page row.

Series System Diagram

System Diagram

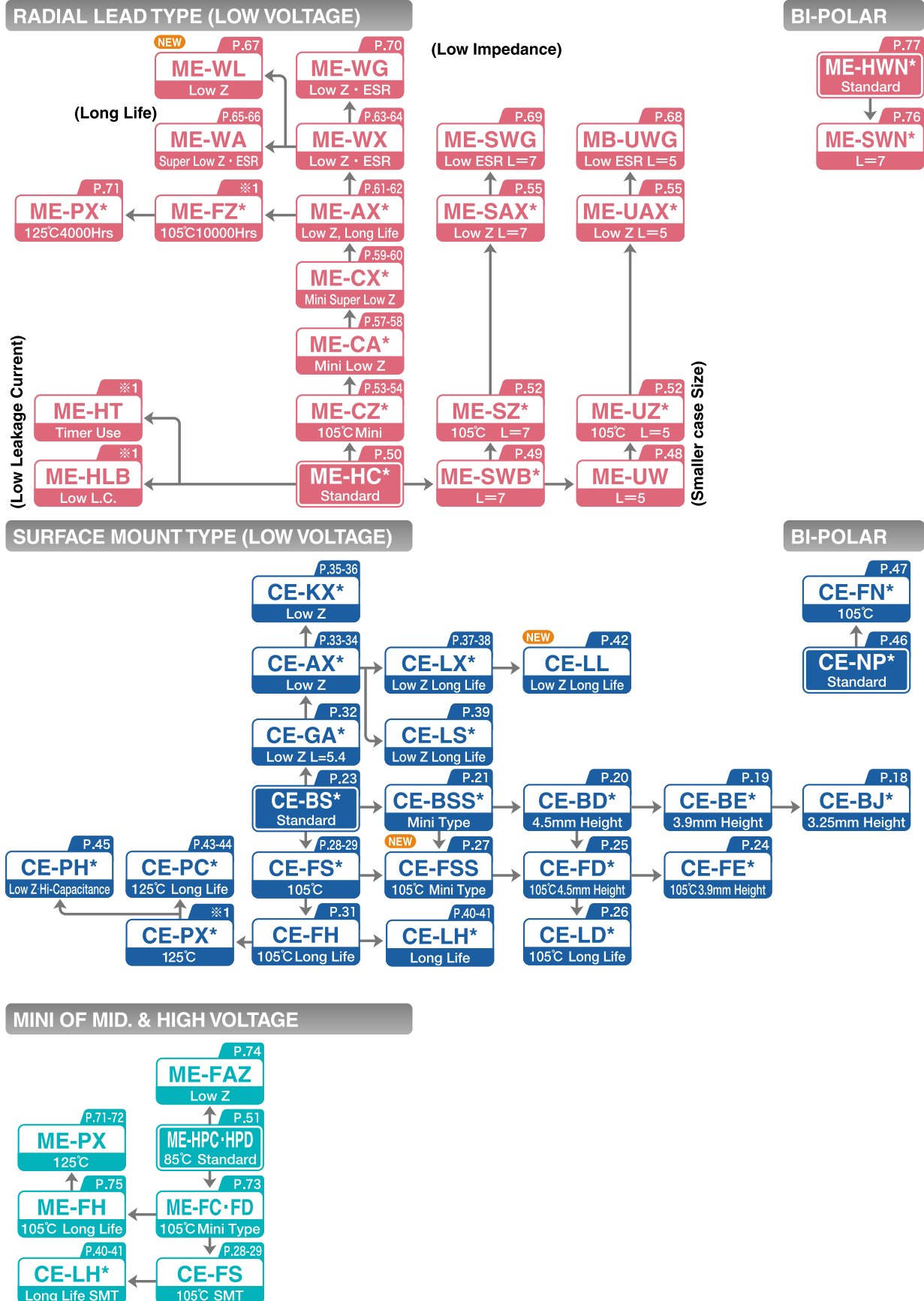

Please refer to <http://www.sunelec.co.jp> for the information in columns where ※1 marking is indicated in a page row.

*solvent proof

Series System Diagram

System Diagram for Power supply

FOR SECONDARY SMOOTHING CIRCUIT

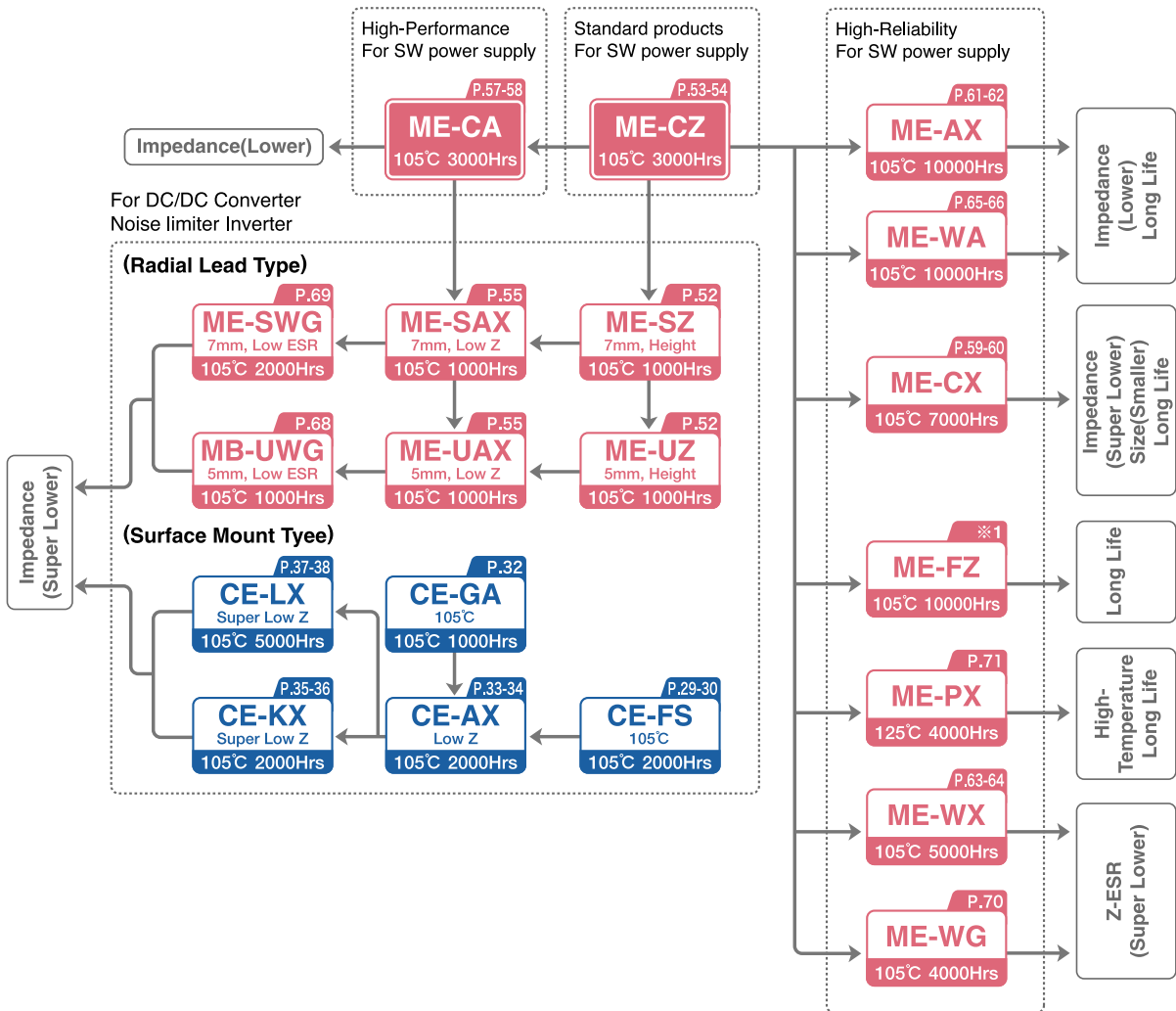

FOR PRIMARY SMOOTHING CIRCUIT

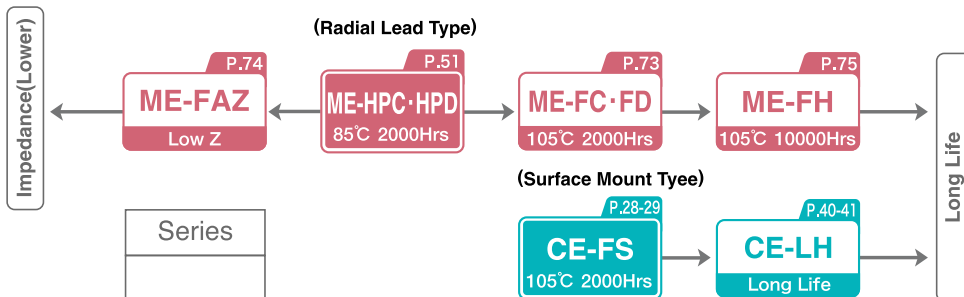

Guidelines and Precautions for Use

Please observe the following guidelines when using aluminum electrolytic capacitors. (Hereafter "Capacitors")

■ Circuit Diagram

- 1) Please use according to the values noted in the catalogue or the specification sheet when considering the application and use of the capacitors.
- 2) Please use according to the temperature range and rated ripple current as noted in the catalogue or the specification sheet.
 - a) Life time of electrolytic capacitors depends on the ambient temperature.
Generally the life time would be doubled as the temperature decreased by 10 degrees.
It is recommended that capacitors be used at a lower temperature than that of the maximum warranty as possible.
 - b) Capacitors should be used at current values within the rated ripple current.
If capacitor bears excessive ripple current, heat generation acutely increases, therefore decreasing capacitance or even damage the capacitor. Please refer to the rated ripple current of each series.
- 3) Please choose the capacitor that matches the lifetime of the intended circuit design.
- 4) Regular capacitors have polarity. If electrical current is applied in the opposite direction to a capacitor's polarity, the result could be a short circuit or destruction of the capacitor.
Bi-polar capacitors should be used in circuit where polarity is occasionally reversed, or where polarity is unknown. (except AC)
- 5) In circuits where frequent charge and discharge are common, capacitance decreases as the internal overheat causes damage to capacitors. In such circuits, please use charge and discharge proof capacitors.
- 6) Do not apply DC-voltage exceeding rated voltage of the capacitors.
- 7) The exterior sleeve of a capacitor is not guaranteed as an insulator.
Do not use the capacitor where insulation is required.
The aluminum case of a capacitor is not insulated from a cathode lead wire.
- 8) Do not use in the following environments.
 - a) In the environments of splashed water, salt water, and oil on the capacitors.
 - b) In the presence of poisonous gas. (Hydrogen sulfide, Sulfurous acid, Chlorine, Ammonia, etc)
 - c) In the environments of applied ozone, ultraviolet rays and radial rays.
 - d) Where vibration or shock exceeds the allowable values as noted in the catalogue or specification sheet.
- 9) Please design after confirming the following points concerning the application and use.
 - a) Please match the leads space with the holes space of the circuit board.
 - b) It is recommended at least 3mm of space around the pressure relief vent.
 - c) Avoid placing to printed wire above the pressure relief vent.
 - d) Make a hole on a circuit board if the top of an aluminum case is positioned below the circuit board at short distance. The hole is to make the passage of gas from a safety vent when the vent opens.
- 10) Avoid having the printed wire under the capacitor.

Guidelines and Precautions for Use

- 11) Avoid placing other parts near or on the opposite side of the circuit board from the capacitor which gives off heat.
- 12) As for the land pattern of surface mount type capacitors, please refer to the values noted in the catalogue or specification sheet.
- 13) Please design after confirming these other following points.
 - a) The performance of the capacitor will vary as the temperature or frequency varies.
 - b) If capacitor is mounted to the double sided circuit board, avoid placing through holes under capacitors.
 - c) Please consider the balance of the current when using two or more capacitors in parallel.
 - d) Please consider the balance of the voltage when using two or more capacitors in series.

■ Mounting

- 1) Do not use a capacitor that has been inserted and connected to a current.
Except for capacitors that have been removed to check the electrical properties during periodical checks, do not reuse.
- 2) In case the capacitor has re-striking-voltage, please discharge through 1k Ω resistor.
- 3) In case the leakage current increases with long term storage, please apply the rated voltage to the capacitor for 30 minutes through 1k Ω of protective series resistors.
- 4) Please mount capacitor after confirmation of following rates : rated capacitance, rated voltage.
- 5) Please mount after confirming the polarity of capacitor.
- 6) Do not drop or use dropped pieces.
- 7) Be careful not to deform the capacitor during installation.
- 8) When mounting capacitors to the circuit board, please use capacitors that the lead space equal the hole space of the circuit board.
- 9) When mounting snap-in type capacitors, please mount close adherence to the circuit board.
- 10) When mounting capacitors with automatic inserting machines, do not apply excessive force to the lead wire or terminals.
- 11) When mounting capacitors with automatic inserting machines, do not apply excessive force to the body of capacitors.
- 12) Please confirm the following points when you solder with a soldering iron.
 - a) Follow the criteria of soldering condition including time and temperature noted in a catalogue or a specification.
 - b) Process the shape of lead wires before soldering when the lead wire space of a capacitor does not match the through hole space of a circuit board, Avoid the stress to the body of the capacitor.
 - c) Melt solder enough to rework a capacitor with a soldering iron after removing it from a circuit board.
Insufficiency of melting solder causes physical stress to lead wires.
 - d) Do not touch the body of a capacitor with the tip of a soldering iron.

Guidelines and Precautions for Use

- 13) Please confirm the following points when you perform flow soldering.
- Do not soak a capacitor in melt solder. Perform flow soldering only on the opposite side of a circuit board where no capacitor is placed.
 - Follow the instruction in a catalogue or a specification with regard to the soldering condition; preheat, soldering temperature, and soaking time.
 - Avoid the attachment of flux to the body of a capacitor except lead wires.
 - Do not locate a capacitor where metal lead wires of the other components contact with the capacitor.
- 14) Please confirm the following points when you perform reflow soldering.
- Follow the specifications for pre-heat, reflow time and peak temperature as noted in the catalogue or specification sheet.
 - The absorption coefficient of infrared rays depends on the color and material of a capacitor.
Avoid heating too much to a capacitor by an infrared heater.
- 15) After mounting the circuit board, do not apply the following mechanical stress.
- Do not apply excessive force to the lead wires or terminals.
 - Do not tilt or bring down the capacitor.
 - Do not pick up circuit board by holding the mounted capacitor.
 - Do not jolt the capacitor. When stacking circuit boards, make sure the capacitor does not come into contact with any other parts.
- 16) In principle, aluminum electrolytic capacitors are not designed to withstand to the cleaning solvent. If cleaning of a board is necessary, select capacitor designed to withstand cleaning process, and observe the cleaning conditions specified in the catalogue or in the manufacturer's specification. Do not clean the capacitors using solvent, unless so specified in catalogue or manufacturer's specification. Use of one of the following chemicals for cleaning may damage the capacitor.
- Solvent containing halogen ions : Damage due to electrolysis of elements
 - Alkaline solvent : Corrosion of the aluminum case
 - Xylene : Degradation of sealing rubber
 - Acetone : Disappearance of markings.
 - Terpene, petro-based solvents : Degradation of sealing rubber
- 17) When cleaning solvent proof capacitors, please confirm the following points.
- Please manage the pollution of the cleaning solvent. (conductivity, pH, specific gravity, content of water, etc)
 - Do not keep in the environments of cleaning solvents or airtight containers, after cleaning the capacitors.
Please dry the circuit board and capacitors in a hot blast stove within upper category temperature or less.
- 18) When using polymer adhesives, select adhesives without halogenated solvents, nor chloroprene.
- 19) Please confirm the following when using coating agents and polymer adhesives.
- When adhesion or coating is performed after cleaning, air dry should be made immediately remove cleaning solvent between capacitors and circuit board.
 - Avoid the treatment that cover the seal of the capacitor, such as coating agents and use of polymer adhesive.

■ During operation or use

- Do not directly touch the capacitor.
- Do not short two lead wires with any conductive material.
Do not spray acid or alkali conductive solution to a capacitor.

Guidelines and Precautions for Use

3) Confirm the following concerning the operating environments.

- a) In the environments of splashed water, salt water, and oil on the capacitors.
- b) Where a capacitor is exposed to direct sunshine.
- c) In the environments of applied ozone, ultraviolet rays and radial rays.
- d) Where vibration or shock exceeds the allowable values as noted in the catalogue or specification sheet.

■ Maintenance · Inspection

1) For industrial use, please periodically check the capacitor.

2) When checking, inspect the following points.

- a) Outside appearance.
- b) Electrical performance. (Leakage current, Capacitance, Tangent of loss angle, etc)

■ In case a problem occurs

1) While using the application, if you see gas, turn off the main power supply to the set or remove the plug from the outlet.

2) When working with a pressure relief vent, high temperature gas spouts out, therefore, do not bring the face close to the capacitor.

3) In case spouted gas got into the eye, immediately wash with the water.

In case you breath spouted gas, immediately rinse out your mouth.

■ Storage conditions

1) Do not store at high temperatures or in high humidity. Please store indoors between 5°C and 35°C at 75% relative humidity or below. Product is safekeeping for less than 1 year after shipment.

2) Do not store where it can come into contact with water, oil, or salt water.

3) Do not store in an environment with poisonous gas. (Hydrogen sulfide, Sulfurous acid, Chlorine, Ammonia, etc)

4) Do not store in an environment that applies ozone, ultraviolet rays, radial rays.

■ Scrap of capacitors

1) Please follow these guidelines when scrapping the capacitors.

- a) Burn after putting a hole in the capacitor or crush the capacitor.
- b) If you do not burn it, please arrange for a professional waste management firm to bury or use other method to scrap.

This guide to use aluminum electrolytic capacitors conform to technical report EIAJ RCR-2367B "Guideline of notabilia for fixed aluminum electrolytic capacitors for use in electronic equipment".
Please refer to this technical report for additional details.

We promote the activities which are considered for ecology.

The environmental products are available with Pb-free products which don't include Pb in terminals of main body and PVC-free products which don't include exterior materials. Please contact us about the specification etc.

Environmental Products (Compliance of RoHS Directive)

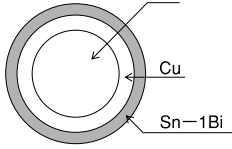
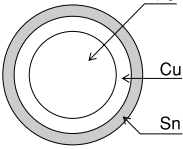
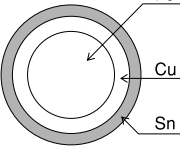
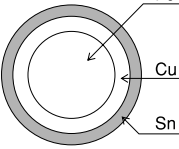
Type code	Surface Mount Type Aluminum Electrolytic Capacitors		Radial Lead Type Aluminum Electrolytic Capacitors	
	CE	CE_T	ME	MB
Kind of coat	Sn-1Bi ($\phi 3$ to $\phi 12.5$) 	Sn ($\phi 16$) 	Sn 	Sn 
Model No. (example)	10CE100BS (100 μ F/10V)	10CE4700BST (4700 μ F/10V)	10ME100AX (100 μ F/10V)	10MB100UWG (100 μ F/10V)
Sleeve	No used	No used	PET	No used
Moisture Sensitivity Level (MSL) [※]	Not applicable No need dry package	Not applicable No need dry package	Not applicable No need dry package	Not applicable No need dry package

([※] Conform to IPC/JEDEC J-STD-020C)

Surface Mount Type Recommended Land Pattern

● land pattern

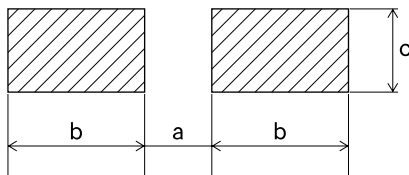

(Unit : mm)

Size	a	b	c
$\phi 3$	0.8	2.2	1.7
$\phi 4$	1.0	2.6	1.8
$\phi 5$	1.4	3.0	1.8
$\phi 6.3$	1.8	3.6	1.8
$\phi 8$	2.8	4.1	2.1
$\phi 10$	4.3	4.4	2.5
$\phi 12.5$	4.3	5.8	2.5
$\phi 16$	6.6	6.5	5.0

When using large surface mount capacitor, please design possibly larger land pattern area than the recommended pattern dimension in order to increase vibration resistance and avoid to falling off a circuit board.

Soldering Condition / Recommended Reflow Condition

■ Soldering Condition

- Soldering with a soldering iron - within 350°C X3 seconds unless otherwise specified in the spec.
- Flow soldering - within 260°C X10 seconds unless otherwise specified in the spec.
- Thermal curing over - ambient temperature within 150°C X2 minutes.

■ Recommended Reflow Condition

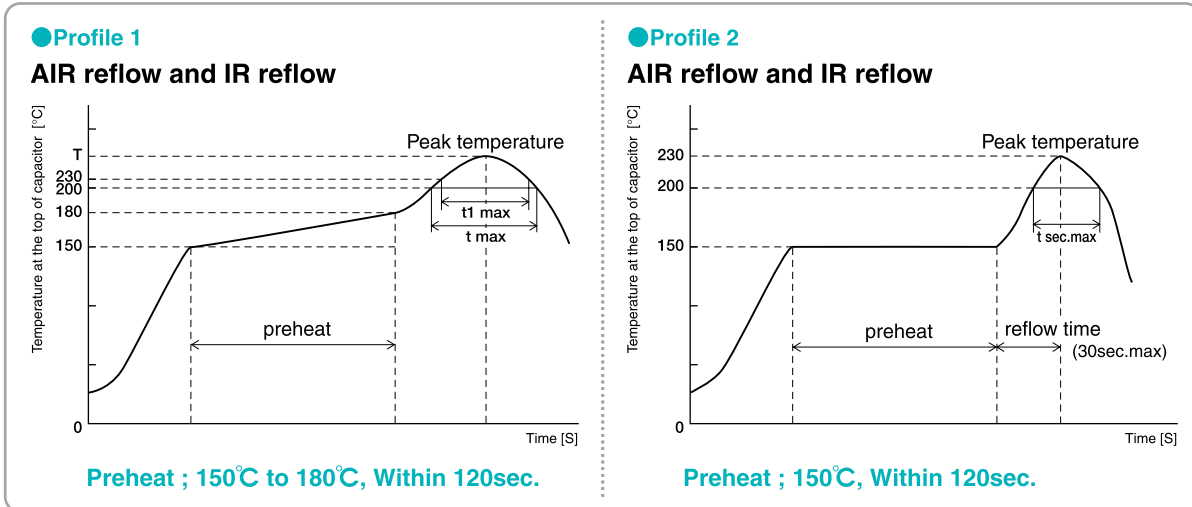

Series	Voltage	Size	Time for more than 200°C (t)	Time for more than 230°C (t1)	Peak temperature (Within 5sec.)	Profile
CE-BSS, CE-C, CE-BS, CE-FSS, CE-FS, CE-FH CE-GA, CE-AX, CE-KX CE-LH, CE-LL, CE-PX CE-NP, CE-FN	4 to 63V	φ 3 to φ 6.3	Within 70sec.	Within 40sec.	250°C	1
		φ 8	Within 60sec.	Within 30sec.	245°C	
		φ 10、φ 12.5	Within 50sec.	Within 20sec.	240°C	
		φ 16	Within 50sec.	Within 15sec.	235°C	
	80 to 100V	φ 4 to φ 6.3	Within 60sec.	Within 40sec.	250°C	
		φ 8	Within 60sec.	Within 30sec.	240°C	
		φ 10	Within 50sec.	Within 20sec.	240°C	
		φ 12.5	Within 50sec.	Within 20sec.	235°C	
	160 to 400V	φ 8、φ 10	Within 50sec.	Within 20sec.	240°C	
		φ 12.5	Within 45sec.	Within 10sec.	235°C	
φ 16		Within 30sec.	—	230°C	2	
CE-LX, CE-LS, CE-PC	6.3 to 50V	φ 4 to φ 8	Within 80sec.	Within 40sec.	260°C	1
		φ 10	Within 70sec.	Within 40sec.	250°C	
		φ 12.5	Within 50sec.	Within 20sec.	240°C	
		φ 16	Within 50sec.	Within 15sec.	235°C	
	63V	φ 8	Within 60sec.	Within 30sec.	245°C	
		φ 10、φ 12.5	Within 50sec.	Within 20sec.	240°C	
		φ 16	Within 50sec.	Within 15sec.	235°C	
	100V	φ 8	Within 60sec.	Within 30sec.	240°C	
		φ 10	Within 50sec.	Within 20sec.	240°C	
		φ 12.5	Within 50sec.	Within 20sec.	235°C	
CE-PH	ALL	φ 8、φ 10	Within 70sec.	Within 40sec.	250°C	
		φ 12.5	Within 50sec.	Within 20sec.	240°C	
CE-BD, CE-FD, CE-LD	ALL	ALL	Within 60sec.	Within 30sec.	245°C	2
CE-BE, CE-FE	ALL	ALL	Within 50sec.	Within 20sec.	240°C	
CE-BJ	ALL	ALL	Within 30sec.	—	230°C	

Capacitors can withstand two reflow processes on the above conditions. Second reflow shall be taken after more than one hour natural cooling time and taken after the return to normal temperatures of PCB board and components. Anti-vibration structure(CA Type) ; Please contact us about the reflow condition.

Packing Specifications

Surface Mount Type Taping Specifications (Unit:mm)

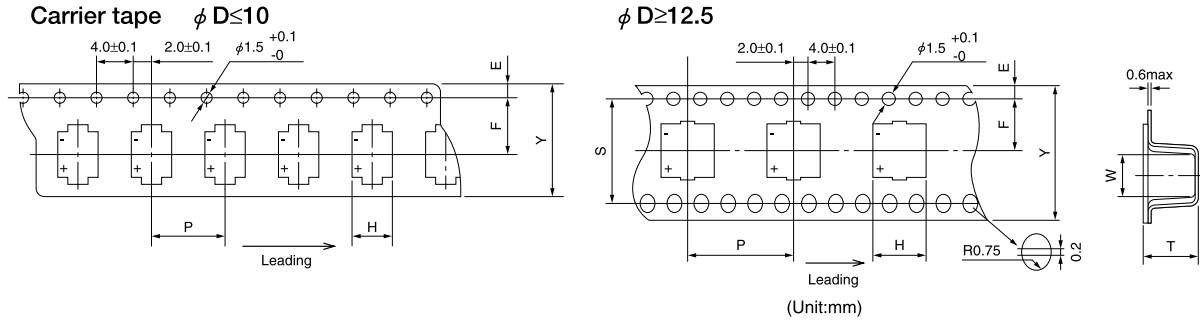

(Unit:mm)

size ($\phi D \times L$)	$Y \pm 0.3$	$H \pm 0.2$	$W \pm 0.2$	$P \pm 0.1$	$E \pm 0.1$	$F \pm 0.1$	$T \pm 0.2$	$S \pm 0.1$
$\phi 6.3 \times 3.25$	16.0	7.0	7.0	12.0	1.75	7.5	3.8	—
$\phi 5 \times 3.9$	12.0	5.7	5.7	12.0	1.75	5.5	4.5	—
$\phi 6.3 \times 3.9$	16.0	7.0	7.0	12.0	1.75	7.5	4.5	—
$\phi 4 \times 4.5$	12.0	4.7	4.7	8.0	1.75	5.5	5.0	—
$\phi 5 \times 4.5$	12.0	5.7	5.7	12.0	1.75	5.5	5.0	—
$\phi 6.3 \times 4.5$	16.0	7.0	7.0	12.0	1.75	7.5	5.1	—
$\phi 3 \times 5.4$	12.0	3.7	3.7	8.0	1.75	5.5	5.8	—
$\phi 4 \times 5.4$	12.0	4.7	4.7	8.0	1.75	5.5	5.8	—
$\phi 5 \times 5.4$	12.0	5.7	5.7	12.0	1.75	5.5	5.8	—
$\phi 5 \times 6.0$	12.0	5.7	5.7	12.0	1.75	5.5	6.4	—
$\phi 6.3 \times 5.4$	16.0	7.0	7.0	12.0	1.75	7.5	5.8	—
$\phi 4 \times 6.0$	12.0	4.7	4.7	8.0	1.75	5.5	6.4	—
$\phi 6.3 \times 6.0$	16.0	7.0	7.0	12.0	1.75	7.5	6.5	—
$\phi 5 \times 7.0$	12.0	5.7	5.7	12.0	1.75	5.5	7.1	—
$\phi 6.3 \times 7.0$	16.0	7.0	7.0	12.0	1.75	7.5	7.5	—
$\phi 6.3 \times 7.7$	16.0	7.0	7.0	12.0	1.75	7.5	8.2	—
$\phi 6.3 \times 8.4$	16.0	7.0	7.0	12.0	1.75	7.5	9.2	—
$\phi 8 \times 10.2(10.5)$	24.0	8.7	8.7	16.0	1.75	11.5	11.1	—
$\phi 10 \times 7.7$	24.0	10.7	10.7	16.0	1.75	11.5	8.3	—
$\phi 10 \times 10.2(10.5)$	24.0	10.7	10.7	16.0	1.75	11.5	11.2	—
$\phi 12.5 \times 13.5$	32.0	13.2	13.2	24.0	1.75	14.2	14.3	28.4
$\phi 16 \times 16.5$	44.0	17.5	17.5	28.0	1.75	20.2	17.3	40.4

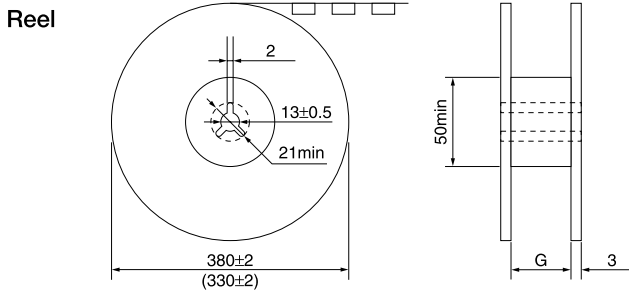

	G
$\phi 3, \phi 4, \phi 5$	14
$\phi 6.3$	18
$\phi 8, \phi 10$	26
$\phi 12.5$	34
$\phi 16$	46

Minimum Packing Quantity

$\phi D \times L$ (mm)	Quantity of 1 Reel ($\phi 380$)	Quantity of 1 Reel ($\phi 330$)	Quantity of 1 package (Reel)
$\phi 3 \times 3.9$	—	1000	5
$\phi 6.3 \times 3.25, 3.9$	—	1000	5
$\phi 4 \times 4.5$	2000	1500 ※	5
$\phi 5 \times 4.5$	—	1000	5
$\phi 6.3 \times 4.5$	—	1000	5
$\phi 3 \times 5.4$	2000	1500 ※	5
$\phi 4 \times 5.4$	2000	1500 ※	5
$\phi 5 \times 5.4$	—	1000	5
$\phi 6.3 \times 5.4$	—	1000	5
$\phi 4 \times 6.0$	2000	1200 ※	5
$\phi 5 \times 6.0$	1000	800 ※	5
$\phi 6.3 \times 6.0$	1000	800 ※	5
$\phi 5 \times 7.0$	1000	—	5
$\phi 6.3 \times 7.0$	1000	—	5
$\phi 6.3 \times 7.7$	900	500 ※	5
$\phi 6.3 \times 8.4$	800	—	5
$\phi 8 \times 10.2(10.5)$	500	300 ※	3
$\phi 10 \times 7.7$	500	400 ※	3
$\phi 10 \times 10.2(10.5)$	500	300 ※	3
$\phi 12.5 \times 13.5$	—	200	2
$\phi 16 \times 16.5$	—	125	2

※ Reel code has to be specified after the model number.

Model No. 25CE47BS+E
 Reel code

When you place an order, please make sure that order should be integral multiple of the minimum packing unit.

Radial Lead Type Taping Specifications for Automatic Inserting Machines

Fig.1

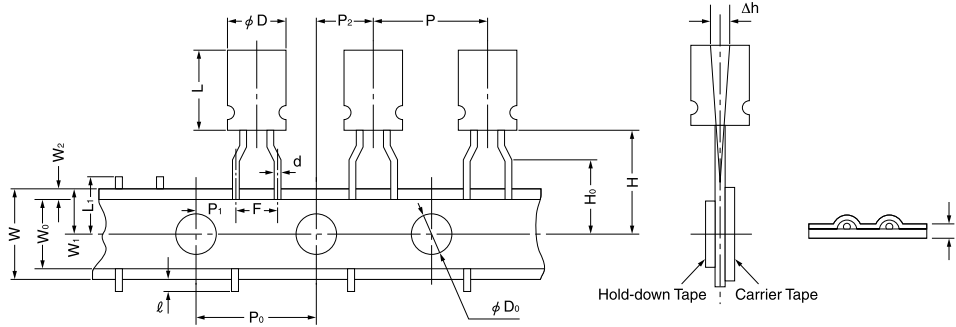

Fig.2

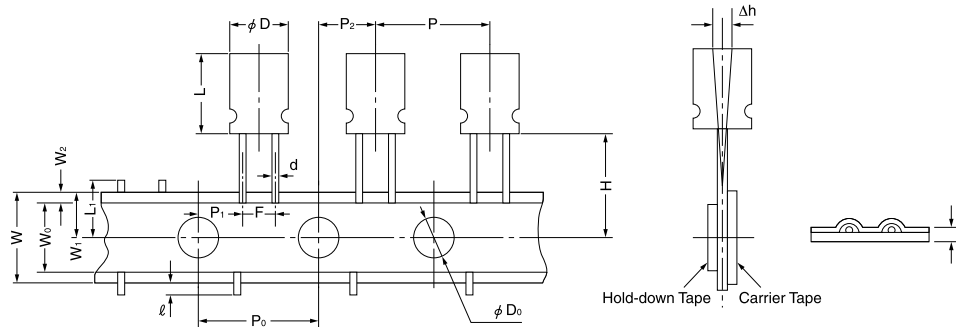
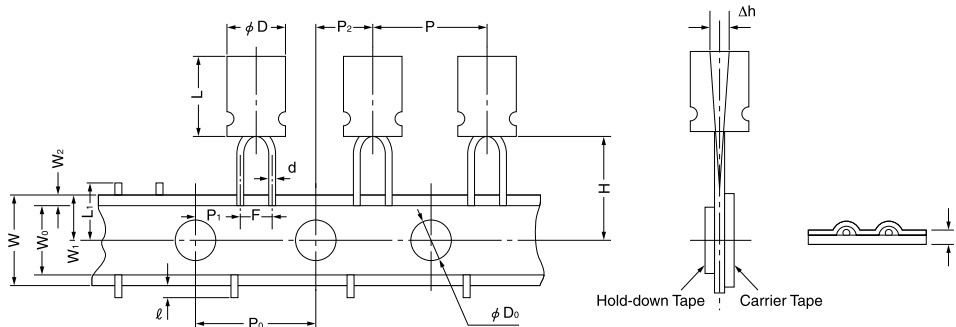

Fig.3



(Unit:mm)

Product Outer Dimensions		φ 6.3x5 φ 4 to φ 6.3x7	φ 5x11 φ 6.3x11	φ 8	φ 10	φ 12.5	φ 16 x 25	φ 4 to φ 5x7	φ 6.3x5 φ 6.3x7	φ 5 x 11	φ 6.3 x 11	φ 8
Fig. No.		1	1	1	2	2	※3	3	2	3	2	2
Lead wire interval	F	^{+0.8} _{-0.2} ※1	5.0	5.0	5.0	5.0	7.5	2.5	2.5	2.5	2.5	3.5
Pitch between components	P	±1.0	12.7	12.7	12.7	12.7	15.0	30.0	12.7	12.7	12.7	12.7
Sprocket hole pitch	P ₀	±0.2	12.7	12.7	12.7	12.7	15.0	15.0	12.7	12.7	12.7	12.7
Sprocket hole position	P ₁	±0.5	3.85	3.85	3.85	3.85	5.0	3.75	5.1	5.1	5.1	4.6
	P ₂	±1.0	6.35	6.35	6.35	6.35	7.5	7.5	6.35	6.35	6.35	6.35
Lateral deviation	Δh	±1.0	0	0	0	0	0	0	0	0	0	0
Carrier tape width	W	±0.5	18.0	18.0	18.0	18.0	18.0	18.0	18.0	18.0	18.0	18.0
Hold-down tape width	W ₀	MIN.	6.0	6.0	6.0	6.0	11.5	11.5	6.0	6.0	6.0	6.0
Sprocket hole position	W ₁	±0.5	9.0	9.0	9.0	9.0	9.0	9.0	9.0	9.0	9.0	9.0
Hold-down tape position	W ₂	MAX.	2.5	2.5	2.5	2.5	2.5	2.5	2.5	2.5	2.5	2.5
Component-base height	H	±0.75 ※2	17.5 ※4	18.5	20.0	16.0 18.5	16.0 18.5	18.5	17.5 18.5	17.5 18.5	18.5	18.5
Lead wire clinch height	H ₀	±0.5	16.0	16.0	16.0	—	—	—	—	—	—	—
Sprocket hole diameter	φ D ₀	±0.2	4.0	4.0	4.0	4.0	4.0	4.0	4.0	4.0	4.0	4.0
Tape thickness(total depth)	t	±0.3	0.6	0.6	0.6	0.6	0.6	0.6	0.6	0.6	0.6	0.6
Lead wire protrusion	ℓ	MAX.	0	0	0	0	0	0	0	0	0	0
Cut position of interior Components	L ₁	MAX.	11.0	11.0	11.0	11.0	11.0	11.0	11.0	11.0	11.0	11.0
Taping code(standard)	Zig-Zag type	+T	+T	+T	+T +T0	+T +T0	+T	+TS	+TSO	+TS +TSO	+TS	+TS

Taping code has to be specified after the model number.

Model No. 16ME100HC+T
 └ Taping code

※1 Fig.2, Fig.3:±0.5

※2 φ 10 · φ 12.5 products (H=18.5): ^{+1.5}_{-0.5}

※3 φ 16 products:Skip one product at Fig.2

Packing Specifications

Radial Lead Type Process Standard Specifications (Unit:mm)

1. Lead wire forming ※

※φD is limited to 5,6.3 or 8mm

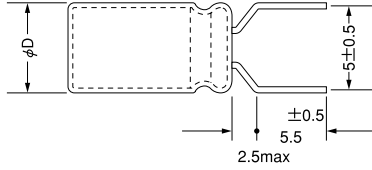

2. Lead wire cutting ※

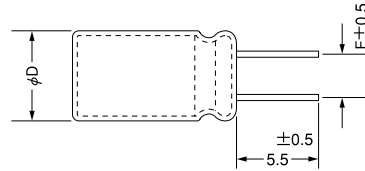

φ D	5	6.3	8	10	12.5	16	18
F	2.0	2.5	3.5	5.0	5.0	7.5	7.5

When ordering, please add the following notations to the end of the model number:

+FA for lead wire forming

+CA for lead wire cutting

Examples of model numbers:

16ME100HC+FA

160ME22HPC+CA

When ordering a capacitor with a lead wire whose length is not listed above, please keep in mind that the notation at the end of the model number changes. Inquire with your supplier.

Model No.

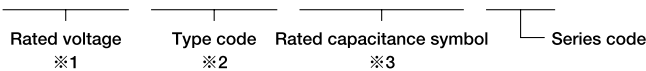

※1. Rated voltage expresses a product mark with 6 about 6.3v.

※2. Type code

- CE: Surface mount type (Environmental products)
- ME: Radial lead type (Environmental products)
- MB: Radial lead type (Environmental products, sleeve less)
- CA: Surface mount type (Anti-vibration structure)

•HV series: Please refer to page 81-82

※3

Rated capacitance(μF)	Symbol
0.10	R1
0.22	R22
1.0	1
4.7	4R7
10	10
100	100
1000	1000
10000	10000

Minimum Packaging Quantity

● Long lead

Size	Quantity	Remarks reference
φ 3 to φ 8 ^{※1}	500 PCS.	※1. φ 8×125L to 20L ; 200 PCS. (WA, WG series Size φ 8×11.5L;200 PCS) ※2. φ 12.5×30L ; 100 PCS. ※3. φ 16×35L ; 50 PCS. Surface Mount Type ; Please refer to page 13
φ 10 to φ 12.5 ^{※2}	200 PCS.	
φ 16 ^{※3}	100 PCS.	
φ 18	50 PCS.	

● Taping

Size	Quantity
φ 3 to φ 4	4000 PCS.
φ 5	3000 PCS.
φ 6.3	2500 PCS.
φ 8	1400 PCS.
φ 10	900 PCS.
φ 12.5	600 PCS.
φ 16	250 PCS.

When you place an order, please make sure that order should be integral multiple of the minimum packing unit.

Ripple Current Frequency Coefficient

■ Ripple Current Frequency Coefficient

Series	Capacitance:C(μF)	Frequency:F(Hz)			
		100≤F<1k	1k≤F<10k	10k≤F<100k	100k≤F
CE-BJ, CE-BE, CE-BD CE-BSS, CE-C, CE-BS CE-FE, CE-FD, CE-LD CE-FSS, CE-FS (6.3 to 100V), CE-FH CE-LH (6.3 to 50V), CE-NP, CE-FN	C≤4.7	1.00	1.30	1.50	1.80
	4.7<C≤33	1.00	1.20	1.30	1.45
	33<C	1.00	1.10	1.20	1.30
CE-GA	C≤4.7	0.07	0.55	0.85	1.00
	1<C≤4.7	0.25	0.60	0.90	1.00
	4.7<C≤47	0.45	0.75	0.92	1.00
	47<C	0.60	0.85	0.92	1.00
CE-AX CE-KX, CE-LX	C≤33	0.35	0.70	0.90	1.00
	33<C≤150	0.40	0.85	0.92	1.00
	150<C	0.60	0.85	0.95	1.00
CE-LS CE-LL, CE-PC	1<C≤22	0.50	0.80	0.90	1.00
	22<C≤150	0.65	0.85	0.92	1.00
	150<C	0.70	0.85	0.95	1.00
CE-PX	ALL ITEM	1.00	1.10	1.20	1.30
CE-PH	ALL ITEM	0.60	0.85	0.93	1.00

Series	Capacitance:C(μF)	Frequency:F(Hz)		
		100≤F<1k	100≤F<10k	10k≤F
ME-UW, ME-UWA, ME-SWB ME-HC, ME-HPC, ME-HPD ME-FC, ME-FD, ME-FH ME-HLB, ME-HT ME-SWN, ME-HWN	C<100	1.00	1.30	1.50
	100≤C<1000	1.00	1.20	1.30
	1000≤C	1.00	1.13	1.15
ME-AX ME-CX	C≤68	0.50	0.80	1.00
	68<C≤220	0.55	0.85	1.00
	220<C≤1000	0.65	0.90	1.00
	1000<C	0.75	0.90	1.00
ME-CZ ME-CA	0.1<C≤1.0	0.20	0.60	1.00
	1<C≤47	0.50	0.80	1.00
	47<C≤220	0.55	0.85	1.00
	220<C≤1000	0.65	0.90	1.00
ME-FZ ME-PX(10 to 100V)	1000<C	0.75	0.90	1.00
	C<4.7	0.40	0.70	1.00
	4.7≤C<100	0.55	0.80	1.00
ME-FAZ	100≤C<1000	0.70	0.90	1.00
	1000≤C	0.90	0.95	1.00
	C<100	0.35	0.54	1.00
	100≤C	0.50	0.70	1.00

Series	Capacitance:C(μF)	Frequency:F(Hz)			
		100≤F<1k	100≤F<10k	10k≤F<100k	100k≤F
ME-UAX ME-SAX	C≤47	0.40	0.80	0.90	1.00
	47<C≤100	0.60	0.75	0.95	1.00
	100<C	0.75	0.85	0.95	1.00
ME-UZ ME-SZ ME-LS	0.1<C≤0.47	0.20	0.50	0.85	1.00
	0.47<C≤4.7	0.50	0.65	0.95	1.00
	4.7<C≤33	0.60	0.75	0.95	1.00
	33<C	0.75	0.85	0.90	1.00
ME-WX ME-WA ME-WL	C≤33	0.40	0.65	0.90	1.00
	33<C≤1200	0.50	0.80	0.93	1.00
	1200<C	0.60	0.85	0.96	1.00
ME-WG	C≤820	0.45	0.80	0.94	1.00
	820<C≤1800	0.50	0.85	0.96	1.00
	1800<C	0.55	0.88	0.98	1.00
MB-UWG ME-SWG	C≤68	0.22	0.45	0.65	1.00
	68<C≤330	0.28	0.50	0.65	1.00

Series	Capacitance:C(μF)	Frequency:F(Hz)				
		50	120	300	1k	10k≤F
CE-FS(160 to 400V) CE-LH(160 to 400V)	ALL ITEM	0.75	1.00	1.20	1.30	1.50
ME-PX (160 to 400V)	C≤33	0.75	1.00	1.25	1.50	1.75
	33<C	0.80	1.00	1.15	1.30	1.40

CA_{Type}



- Peak acceleration:30G
- Suitable for Automotive Application

Specifications

Items	Specifications
Vibration	Peak acceleration : 30G
	Peak to peak amplitude : 5mm
	Frequency : 5 to 2,000Hz reciprocation for 20 min.
	Direction and duration of vibration : 3 orthogonal directions mutually each for 2h.
$\Delta C/C$	Within $\pm 5\%$ of the initial value
$\tan \delta$	\leq The initial specified value
LC	\leq The initial specified value

Dimensions

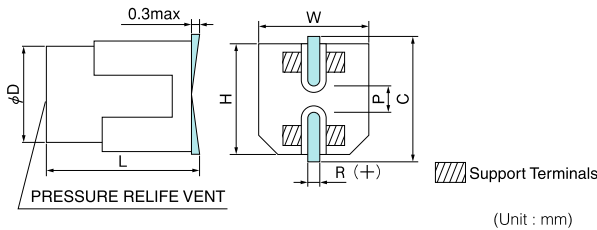

D ^{+0.5max}	L	W ^{±0.2}	H ^{±0.2}	C ^{±0.2}	R	P ^{±0.2}
8	10.5 ±0.5	8.3	8.3	9.0	0.7~1.0	3.2
10	10.5 ±0.5	10.3	10.3	11.0	1.0~1.4	4.6
12.5	13.5 ±1.0	13.5	13.5	14.2	1.0~1.4	4.6
16	16.5 ±1.0	17.0	17.0	18.0	1.8~2.1	7.0

Surface Mount Type Recommended land pattern

land pattern (Anti-vibration Structure)

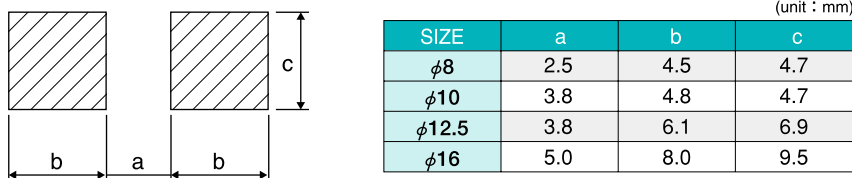

Model No.

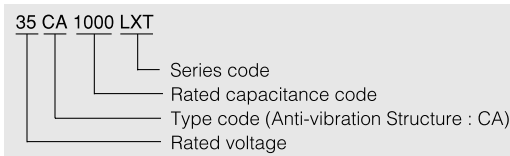

Available for φ8~φ16 in all series of SMT type.

CE-BJ Series

Super Low Profile

3.25mm Height



• Solvent proof (within 2 minutes)

Specifications

Items	Condition	Specifications							
Rated voltage (V)	—	4.0	6.3	10	16	25	35	50	
Surge voltage (V)	Room temperature	5.0	8.0	13	20	32	44	63	
Category temperature range (°C)	—	-40 to +85							
Capacitance tolerance (%)	120Hz/20°C	M : ±20							
Dissipation Factor (DF)	120Hz/20°C	0.40	0.35	0.24	0.20	0.16	0.14	0.12	
Leakage current (LC)	μ A/after 2minutes (max)	0.01CV							
Impedance ratio at low temperature	Based the value at 120Hz, +20°C	-25°C Z/Z _{20°C}	7	4	3	2	2	2	2
		-40°C Z/Z _{20°C}	15	10	8	6	4	4	4
Endurance	85°C, 1,000hrs. rated voltage applied (With the rated ripple current)	ΔC/C	Within ±25% of the initial value						
		tan δ	≤ 2 times the initial specified value						
		LC	≤ The initial specified value						

Marking, Dimensions

Polarity (Cathode)

Lot No.

80 Rated Capacitance

33 Series Symbol

16 J Rated Voltage(6.3V→6)

(Unit : mm)

D ^{+0.5max}	L ^{+0.1 -0.2}	W ^{±0.2}	H ^{±0.2}	C ^{±0.2}	R	P ^{±0.2}
6.3	3.25	6.6	6.6	7.3	0.5 to 0.8	2.2

Size List, Rated Ripple Current

μF \ V	4.0	6.3	10	16	25	35	50
10							6.3 x 3.25 31
15						6.3 x 3.25 44	
22					6.3 x 3.25 46		
33				6.3 x 3.25 46			
47			6.3 x 3.25 51				
68		6.3 x 3.25 60					
82	6.3 x 3.25 60						

Please refer to page 16 for the ripple current frequency coefficient.

Case size ; φ D x L (mm) | Rated ripple current mA rms (120Hz, 85°C)

Model No. 16 CE 33 BJ

- 16: Rated voltage
- CE: Series code
- 33: Rated capacitance code
- BJ: Type code

CE-BE Series

Miniature Low Profile

3.9mm Height



- Solvent proof (within 2 minutes)

Specifications

Items	Condition	Specifications							
Rated voltage (V)	—	4.0	6.3	10	16	25	35	50	
Surge voltage (V)	Room temperature	5.0	8.0	13	20	32	44	63	
Category temperature range (°C)	—	-40 to +85							
Capacitance tolerance (%)	120Hz/20°C	M : ±20							
Dissipation Factor (DF)	120Hz/20°C	0.40	0.30	0.24	0.20	0.16	0.14	0.12	
Leakage current (LC)	μA/after 2minutes (max)	The greater value of either 0.01CV or 3							
Impedance ratio at low temperature	Based the value at 120Hz, +20°C	-25°C Z/Z _{20°C}	7	4	3	2	2	2	2
		-40°C Z/Z _{20°C}	15	10	8	6	4	4	4
Endurance	85°C, 1,000hrs. rated voltage applied (With the rated ripple current)	ΔC/C	Within ±25% of the initial value						
		tan δ	≤ 2 times the initial specified value						
		LC	≤ The initial specified value						

Marking, Dimensions

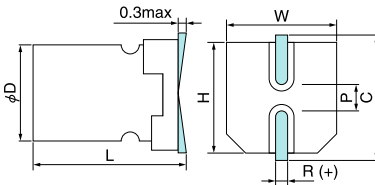
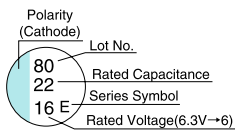

(Unit : mm)

D ^{+0.5max}	L ^{+0.1 -0.2}	W ^{+0.2}	H ^{+0.2}	C ^{+0.2}	R	P ^{+0.2}
5	3.9	5.3	5.3	6.0	0.5 to 0.8	1.4
6.3	3.9	6.6	6.6	7.3	0.5 to 0.8	2.2

Size List, Rated Ripple Current

μF \ V	4.0	6.3	10	16	25	35	50
1.0							5 x 3.9 8.4
2.2							5 x 3.9 14
3.3							5 x 3.9 17
4.7					5 x 3.9 18	5 x 3.9 18	5 x 3.9 21
10				5 x 3.9 25	5 x 3.9 30	5 x 3.9 29	6.3 x 3.9 33
22		5 x 3.9 33	5 x 3.9 35	6.3 x 3.9* 45(37)	6.3 x 3.9 50	6.3 x 3.9 49	
33	5 x 3.9 33	5 x 3.9 40	6.3 x 3.9* 50(43)	6.3 x 3.9 50	6.3 x 3.9 60		
47	5 x 3.9 40	6.3 x 3.9* 60(48)	6.3 x 3.9 55	6.3 x 3.9 60			
68	6.3 x 3.9* 60(48)	6.3 x 3.9 70					
100	6.3 x 3.9* 70(58)	6.3 x 3.9 75					
180	6.3 x 3.9 85						

Please refer to page 16 for the ripple current frequency coefficient.

Case size ; φ D x L (mm)
※ CE-BES (5 x 3.9)

Rated ripple current
mA rms (120Hz, 85°C)
() ; CE-BES series

Model No.

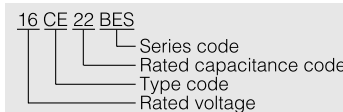
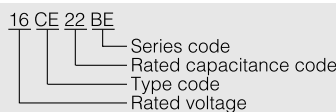

CE-BD Series

Miniature Low Profile

4.5mm Height



• Solvent proof (within 2 minutes)

Specifications

Items	Condition	Specifications							
Rated voltage (V)	—	4.0	6.3	10	16	25	35	50	
Surge voltage (V)	Room temperature	5.0	8.0	13	20	32	44	63	
Category temperature range (°C)	—	-40 to +85							
Capacitance tolerance (%)	120Hz/20°C	M : ±20							
Dissipation Factor (DF)	120Hz/20°C	0.40	0.30	0.24	0.20	0.16	0.14	0.12	
Leakage current (LC)	μA/after 2minutes (max)	The greater value of either 0.01CV or 3							
Impedance ratio at low temperature	Based the value at 120Hz, +20°C	-25°C Z/Z _{20°C}	7	4	3	2	2	2	2
		-40°C Z/Z _{20°C}	15	10	8	6	4	4	4
Endurance	85°C, 1,000hrs. rated voltage applied (With the rated ripple current)	ΔC/C	Within ±25% of the initial value						
		tan δ	≤ 2 times the initial specified value						
		LC	≤ The initial specified value						

Marking, Dimensions

Polarity (Cathode)

Lot No.

80 Rated Capacitance

22 Series Symbol

16 V Rated Voltage(6.3V→6)

(Unit : mm)

D ^{+0.5max}	L ^{+0.1 -0.2}	W ^{±0.2}	H ^{±0.2}	C ^{±0.2}	R	P ^{±0.2}
4	4.5	4.3	4.3	5.0	0.5 to 0.8	1.0
5	4.5	5.3	5.3	6.0	0.5 to 0.8	1.4
6.3	4.5	6.6	6.6	7.3	0.5 to 0.8	2.2

Size List, Rated Ripple Current

μF \ V	4.0	6.3	10	16	25	35	50
0.10							4 x 4.5 1.0
0.22							4 x 4.5 2.0
0.33							4 x 4.5 2.8
0.47							4 x 4.5 4.0
1.0							4 x 4.5 8.4
2.2							4 x 4.5 14
3.3							4 x 4.5 17
4.7					4 x 4.5 17	4 x 4.5 18	5 x 4.5 21
10				4 x 4.5 23	5 x 4.5 27	5 x 4.5 29	6.3 x 4.5 33
22		4 x 4.5 28	5 x 4.5 33	5 x 4.5 37	6.3 x 4.5 47	6.3 x 4.5 49	
33	4 x 4.5 28	5 x 4.5 37	5 x 4.5 41	6.3 x 4.5 51	6.3 x 4.5 57		
47	4 x 4.5 33	5 x 4.5 45	6.3 x 4.5 53	6.3 x 4.5 61			
100	5 x 4.5 56	6.3 x 4.5 70	6.3 x 4.5 74				
220	6.3 x 4.5 96						

Please refer to page 16 for the ripple current frequency coefficient.

Case size ; φ D x L (mm)

Rated ripple current
mA_{rms} (120Hz, 85°C)

■ Model No.

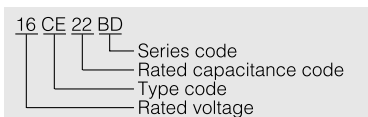

CE-BSS Series

Miniature High Capacitance

5.4mm Height



- Solvent proof (within 2 minutes)

Specifications

Items	Condition	Specifications						
Rated voltage (V)	—	6.3	10	16	25	35	50	
Surge voltage (V)	Room temperature	8.0	13	20	32	44	63	
Category temperature range (°C)	—	-40 to +85						
Capacitance tolerance (%)	120Hz/20°C	M : ±20						
Dissipation Factor (DF)	120Hz/20°C	0.28	0.24	0.20	0.16	0.14	0.12	
Leakage current (LC)	μA/after 2minutes (max)	The greater value of either 0.01CV or 3						
Impedance ratio at low temperature	Based the value at 120Hz, +20°C	-25°C Z/Z _{20°C}	4	3	2	2	2	2
		-40°C Z/Z _{20°C}	10	8	6	4	4	4
Endurance	85°C, 2,000hrs. rated voltage applied (With the rated ripple current)	ΔC/C	Within ±25% of the initial value					
		tan δ	≤ 2 times the initial specified value					
		LC	≤ The initial specified value					

Marking, Dimensions

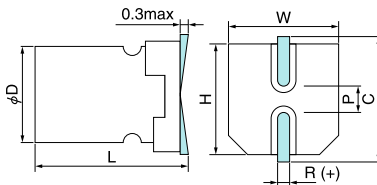
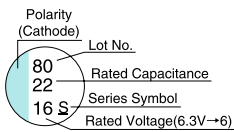

(Unit : mm)

D ^{+0.5max}	L ^{+0.1 -0.2}	W ^{+0.2}	H ^{+0.2}	C ^{-0.2}	R	P ^{±0.2}
4	5.4	4.3	4.3	5.0	0.5 to 0.8	1.0
5	5.4	5.3	5.3	6.0	0.5 to 0.8	1.4
6.3	5.4	6.6	6.6	7.3	0.5 to 0.8	2.2

Size List, Rated Ripple Current

μF \ V	6.3	10	16	25	35	50
4.7						4 x 5.4 18
10				4 x 5.4 20	4 x 5.4 20	5 x 5.4 27
22		4 x 5.4 28	4 x 5.4 28	5 x 5.4 35	5 x 5.4 36	6.3 x 5.4 40
33	4 x 5.4 31	4 x 5.4 32	5 x 5.4 40	5 x 5.4 42	6.3 x 5.4 58	
47	4 x 5.4 36	5 x 5.4 43	5 x 5.4 44	6.3 x 5.4 65		
56	5 x 5.4 46	5 x 5.4 46	5 x 5.4 48	6.3 x 5.4 68		
100	5 x 5.4 47	5 x 5.4 50				
150	6.3 x 5.4 71	6.3 x 5.4 76				
220	6.3 x 5.4 74					

Please refer to page 16 for the ripple current frequency coefficient.

Case size ; ϕ D x L (mm)

Rated ripple current
mA Arms (120Hz, 85°C)

Model No.

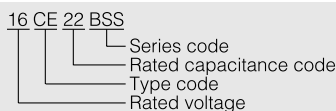

CE-C Series

Ultra Mini Version, 3mm in Diameter



- Solvent proof (within 2 minutes)

Specifications

Items	Condition	Specifications						
Rated voltage (V)	—	4.0	6.3	16	25	35	50	
Surge voltage (V)	Room temperature	5.0	8.0	20	32	44	63	
Category temperature range (°C)	—	-40 to +85						
Capacitance tolerance (%)	120Hz/20°C	M : ±20						
Dissipation Factor (DF)	120Hz/20°C	0.40	0.30	0.19	0.16	0.14	0.14	
Leakage current (LC)	μA/after 2minutes (max)	The greater value of either 0.01CV or 3						
Impedance ratio at low temperature	Based the value at 120Hz, +20°C	-25°C	Z/Z _{20°C}	7	4	2	2	2
		-40°C	Z/Z _{20°C}	15	10	6	4	4
Endurance	85°C, 2,000hrs. rated voltage applied (With the rated ripple current)	ΔC/C	Within ±25% of the initial value					
		tan δ	≤ 2 times the initial specified value					
		LC	≤ The initial specified value					

Marking, Dimensions

Polarity (Cathode)

Lot No.

(Unit : mm)

D ^{+0.5max}	L ^{+0.1 -0.2}	W ^{±0.2}	H ^{±0.2}	C ^{±0.2}	R	P ^{±0.2}
3	5.4	3.3	3.3	3.9	0.45 to 0.75	0.6

Size List, Rated Ripple Current

μF	V	4.0		6.3		16		25		35		50	
0.10												3 x 5.4	1
0.22												3 x 5.4	2
0.33												3 x 5.4	3
0.47												3 x 5.4	4
1.0												3 x 5.4	8
2.2										3 x 5.4	8	3 x 5.4	10
3.3										3 x 5.4	10		
4.7								3 x 5.4	12				
10						3 x 5.4	18						
22		3 x 5.4	19	3 x 5.4	19								

Please refer to page 16 for the ripple current frequency coefficient.

Case size ; φ D x L (mm)

Rated ripple current
mA rms (120Hz, 85°C)

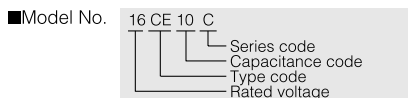

CE-BS Series

Standard



- Solvent proof (within 2 minutes)

Specifications

Items	Condition	Specifications									
Rated voltage (V)	—	4.0	6.3	10	16	25	35	50	63	100	
Surge voltage (V)	Room temperature	5.0	8.0	13	20	32	44	63	79	125	
Category temperature range (°C)	—	-40 to +85									
Capacitance tolerance (%)	120Hz/20°C	M : ±20									
Dissipation Factor (DF)	120Hz/20°C	φ 4 to φ 6.3	0.35	0.26	0.20	0.16	0.14	0.12	0.12	0.12	0.10
		φ 8 to φ 16	0.40	0.30	0.24	0.20	0.16	0.14	0.12	0.12	0.10
		When rated capacitance exceeds 1,000 μF, add 0.02 to the value above for each 1,000 μF increase.									
Leakage current (LC)	μ A/after 2minutes (max)	The greater value of either 0.01CV or 3									
Impedance ratio at low temperature	Based the value at 120Hz, +20°C	-25°C Z/Z _{20°C}	7	4	3	2	2	2	2	2	2
		-40°C Z/Z _{20°C}	15	8	6	4	4	3	3	3	3
Endurance	85°C, 2,000hrs. rated voltage applied (With the rated ripple current)	ΔC/C	Within ±25% of the initial value								
		tan δ	≤ 2 times the initial specified value								
		LC	≤ The initial specified value								

Marking, Dimensions

(Unit : mm)

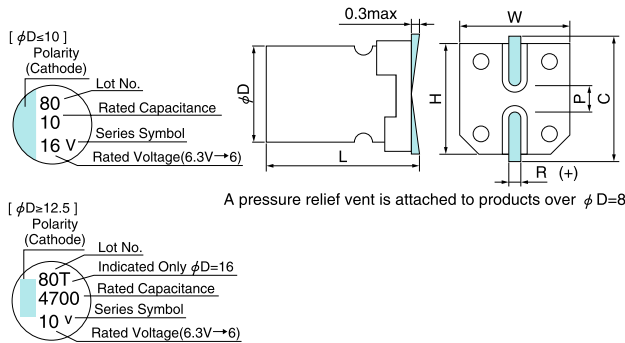

D _{±0.5max}	L	W _{±0.2}	H _{±0.2}	C _{±0.2}	R	P _{±0.2}
4	5.4 ^{+0.1} _{-0.2}	4.3	4.3	5.0	0.5 to 0.8	1.0
5	5.4 ^{+0.1} _{-0.2}	5.3	5.3	6.0	0.5 to 0.8	1.4
6.3	5.4 ^{+0.1} _{-0.2}	6.6	6.6	7.3	0.5 to 0.8	2.2
4	6.0 ^{±0.3}	4.3	4.3	5.0	0.5 to 0.8	1.0
6.3	6.0 ^{±0.3}	6.6	6.6	7.3	0.5 to 0.8	2.2
6.3	7.7 ^{±0.3}	6.6	6.6	7.3	0.5 to 0.8	2.2
8	10.2 ^{±0.3}	8.3	8.3	9.0	0.7 to 1.0	3.2
10	7.7 ^{±0.3}	10.3	10.3	11.0	1.0 to 1.4	4.6
10	10.2 ^{±0.3}	10.3	10.3	11.0	1.0 to 1.4	4.6
12.5	13.5 ^{±0.5}	12.8	12.8	13.5	1.0 to 1.4	4.6
16	16.5 ^{±0.5}	16.3	16.3	17.3	1.8 to 2.1	7.0

Size List, Rated Ripple Current

μF	V	4.0	6.3	10	16	25	35	50	63	100								
0.1 to 0.47								4x5.4	1 to 5	4x5.4	1 to 5							
1.0								4x5.4	10	4x5.4	10	4x6.0	10					
2.2								4x5.4	15	4x5.4	15	6.3x6.0	20					
3.3								4x5.4	18	5x5.4	20	6.3x6.0	28					
4.7						4x5.4	19	4x5.4	20	5x5.4	23	6.3x6.0	35					
10					4x5.4	25	5x5.4	28	5x5.4	30	6.3x5.4	34	6.3x5.4	34	6.3x7.7	50		
22			4x5.4	31	5x5.4	35	5x5.4	39	6.3x5.4	52	6.3x5.4	54	6.3x6.0	60	6.3x7.7	70	8x10.2	120
33	4x5.4	26	5x5.4	39	5x5.4	43	6.3x5.4	57	6.3x5.4	63	6.3x6.0	60	6.3x7.7	85	8x10.2	160	10x10.2	190
47	4x5.4	34	5x5.4	47	6.3x5.4	59	6.3x5.4	68	6.3x6.0	68	6.3x6.0	70	6.3x7.7	90	8x10.2	170	12.5x13.5	330
68															8x10.2	180	12.5x13.5	350
82												10x7.7	200					
100	5x5.4	61	6.3x5.4	71	6.3x5.4	76	6.3x5.4	86	6.3x7.7	130	6.3x7.7	120	8x10.2	200	10x10.2	280	16x16.5	550
150					6.3x6.0	88	6.3x7.7	135	8x10.2	200	8x10.2	220					16x16.5	560
220									10x7.7	220								
330	6.3x6.0	102	6.3x7.7	150	8x10.2	280	8x10.2	280	8x10.2	310	10x10.2	340	12.5x13.5	520				
390													12.5x13.5	550				
470	6.3x7.7	150	8x10.2	300	8x10.2	300	8x10.2	330	10x10.2	430	12.5x13.5	590			16x16.5	700		
680			8x10.2	300	10x7.7	300	10x10.2	450			12.5x13.5	610	16x16.5	1000				
1000			8x10.2	330	10x10.2	450					12.5x13.5	660	16x16.5	1000	16x16.5	940		
1500																		
2200			10x10.2	450			12.5x13.5	710										
3300																		
4700			12.5x13.5	750														
6800							16x16.5	1260										

Please refer to page 16 for the ripple current frequency coefficient.

■ Model No.

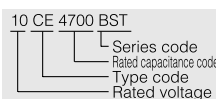
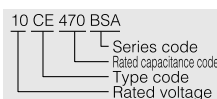
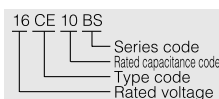

Case size : φ D x L (mm)
10 x 7.7 : CE-BSA series
16 x 16.5 : CE-BST series

Rated ripple current
mA Arms (120Hz, 85°C)

CE-FE Series

Miniature Low Profile

3.9mm Height



- 105°C, 1,000hrs
- Solvent proof (within 2 minutes)

Specifications

Items	Condition	Specifications						
Rated voltage (V)	—	6.3	10	16	25	35	50	
Surge voltage (V)	Room temperature	8.0	13	20	32	44	63	
Category temperature range (°C)	—	-40 to +105						
Capacitance tolerance (%)	120Hz/20°C	M : ±20						
Dissipation Factor (DF)	120Hz/20°C	0.38	0.32	0.20	0.16	0.14	0.14	
Leakage current (LC)	μA/after 2minutes (max)	The greater value of either 0.01CV or 3						
Impedance ratio at low temperature	Based the value at 120Hz, +20°C	-25°C Z/Z _{20°C}	4	3	2	2	2	2
		-40°C Z/Z _{20°C}	10	8	6	4	4	4
Endurance	105°C, 1,000hrs. rated voltage applied (With the rated ripple current)	ΔC/C	Within ±30% of the initial value					
		tan δ	≤ 3 times the initial specified value					
		LC	≤ The initial specified value					

Marking, Dimensions

Polarity (Cathode)

Lot No.

80 Rated Capacitance

33 Series Symbol

16F Rated Voltage(6.3V→6)

(Unit : mm)

D ^{+0.5max}	L ^{+0.1 -0.2}	W ^{±0.2}	H ^{±0.2}	C ^{±0.2}	R	P ^{±0.2}
5	3.9	5.3	5.3	6.0	0.5 to 0.8	1.4
6.3	3.9	6.6	6.6	7.3	0.5 to 0.8	2.2

Size List, Rated Ripple Current

μF \ V	6.3	10	16	25	35	50
1.0						5 x 3.9 6
2.2						5 x 3.9 10
3.3						5 x 3.9 12
4.7				5 x 3.9 13	5 x 3.9 13	5 x 3.9 16
10			5 x 3.9 18	5 x 3.9 21	5 x 3.9 22	6.3 x 3.9 23
22	5 x 3.9 23	5 x 3.9 25	6.3 x 3.9 * 31(26)	6.3 x 3.9 35	6.3 x 3.9 34	
33	5 x 3.9 28	6.3 x 3.9 * 35(30)	6.3 x 3.9 35	6.3 x 3.9 42		
47	6.3 x 3.9 * 42(34)	6.3 x 3.9 38	6.3 x 3.9 42			
68	6.3 x 3.9 49					
100	6.3 x 3.9 52					

* CE-FES (5 x 3.9)

Please refer to page 16 for the ripple current frequency coefficient.

Case size ; φ D x L (mm)

Rated ripple current
mA rms (120Hz, 105°C)
() ; CE-FES series

Model No.

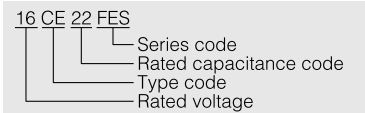
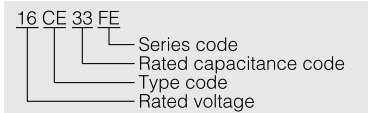

CE-FD Series

Miniature Low Profile

4.5mm Height



- 105°C, 1,000hrs
- Solvent proof (within 2 minutes)

Specifications

Items	Condition	Specifications						
Rated voltage (V)	—	6.3	10	16	25	35	50	
Surge voltage (V)	Room temperature	8.0	13	20	32	44	63	
Category temperature range (°C)	—	-40 to +105						
Capacitance tolerance (%)	120Hz/20°C	M : ±20						
Dissipation Factor (DF)	120Hz/20°C	0.35	0.28	0.20	0.16	0.14	0.12	
Leakage current (LC)	μA/after 2minutes (max)	The greater value of either 0.01CV or 3						
Impedance ratio at low temperature	Based the value at 120Hz, +20°C	-25°C Z/Z _{20°C}	4	3	2	2	2	2
		-40°C Z/Z _{20°C}	10	8	6	4	4	4
Endurance	105°C, 1,000hrs. rated voltage applied (With the rated ripple current)	ΔC/C	Within ±25% of the initial value					
		tan δ	≤ 3 times the initial specified value					
		LC	≤ The initial specified value					

Marking, Dimensions

Polarity (Cathode)

Lot No.

80 Rated Capacitance

22 Series Symbol

16 F Rated Voltage(6.3V→6)

(Unit : mm)

D ^{+0.5max}	L ^{+0.1 -0.2}	W ^{+0.2}	H ^{+0.2}	C ^{+0.2}	R	P ^{+0.2}
4	4.5	4.3	4.3	5.0	0.5 to 0.8	1.0
5	4.5	5.3	5.3	6.0	0.5 to 0.8	1.4
6.3	4.5	6.6	6.6	7.3	0.5 to 0.8	2.2

Size List, Rated Ripple Current

μF \ V	6.3		10		16		25		35		50	
0.10											4 x 4.5	0.7
0.22											4 x 4.5	1.4
0.33											4 x 4.5	2.0
0.47											4 x 4.5	2.8
1.0											4 x 4.5	5.9
2.2											4 x 4.5	9.8
3.3											4 x 4.5	12
4.7							4 x 4.5	12	4 x 4.5	13	5 x 4.5	15
10					4 x 4.5	17	5 x 4.5	19	5 x 4.5	21	6.3 x 4.5	24
22	4 x 4.5	20	5 x 4.5	24	5 x 4.5	26	6.3 x 4.5	33	6.3 x 4.5	35		
33	5 x 4.5	26	5 x 4.5	29	6.3 x 4.5	36	6.3 x 4.5	40				
47	5 x 4.5	32	6.3 x 4.5	38	6.3 x 4.5	43						
100	6.3 x 4.5	49	6.3 x 4.5	52								

Please refer to page 16 for the ripple current frequency coefficient.

Case size ; φ D x L (mm)

Rated ripple current
mA Arms (120Hz, 105°C)

Model No.

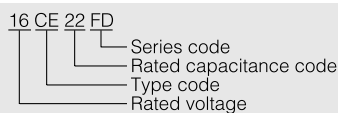

CE-LD Series

Low Profile 4.5mm Height

Long Life



- 105°C, 2,000 to 3,000hrs
- Solvent proof (within 2 minutes)

Specifications

Items	Condition	Specifications						
Rated voltage (V)	—	6.3	10	16	25	35	50	
Surge voltage (V)	Room temperature	8.0	13	20	32	44	63	
Category temperature range (°C)	—	-40 to +105						
Capacitance tolerance (%)	120Hz/20°C	M : ±20						
Dissipation Factor (DF)	120Hz/20°C	0.35	0.30	0.20	0.16	0.14	0.12	
Leakage current (LC)	μA/after 2minutes (max)	The greater value of either 0.01CV or 3						
Impedance ratio at low temperature	Based the value at 120Hz, +20°C	-25°C Z/Z _{20°C}	4	3	2	2	2	2
		-40°C Z/Z _{20°C}	10	8	6	4	4	4
Endurance	105°C rated voltage applied (With the rated ripple current)	Test	φ 4 to φ 5 : 2,000hrs., φ 6.3 : 3,000hrs.					
		ΔC/C	Within ±30% of the initial value					
		tan δ	≤ 3 times the initial specified value					
		LC	≤ The initial specified value					

Marking, Dimensions

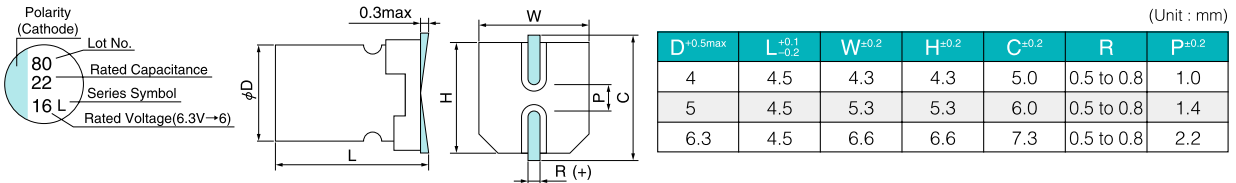

Size List, Rated Ripple Current

μF \ V	6.3	10	16	25	35	50
0.10						4 x 4.5 0.7
0.22						4 x 4.5 1.4
0.33						4 x 4.5 2.0
0.47						4 x 4.5 2.8
1.0						4 x 4.5 5.9
2.2						4 x 4.5 10
3.3						4 x 4.5 12
4.7				4 x 4.5 12	4 x 4.5 13	5 x 4.5 15
10			4 x 4.5 17	5 x 4.5 19	5 x 4.5 24	6.3 x 4.5 24
22	4 x 4.5 20	5 x 4.5 24	5 x 4.5 26	6.3 x 4.5 33	6.3 x 4.5 35	
33	5 x 4.5 26	5 x 4.5 29	6.3 x 4.5 36	6.3 x 4.5 40		
47	5 x 4.5 32	6.3 x 4.5 38	6.3 x 4.5 43			
100	6.3 x 4.5 49	6.3 x 4.5 52				

Please refer to page 16 for the ripple current frequency coefficient.

Case size ; φ D x L (mm)

Rated ripple current
mA Arms (120Hz, 105°C)

Model No.

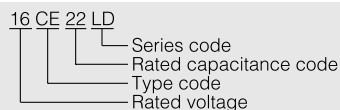

CE-FSS Series

Miniature High Capacitance

5.4mm Height



- Solvent proof (within 2 minutes)

Specifications

Items	Condition	Specifications						
Rated voltage (V)	—	6.3	10	16	25	35	50	
Surge voltage (V)	Room temperature	8.0	13	20	32	44	63	
Category temperature range (°C)	—	-40 to +105						
Capacitance tolerance (%)	120Hz/20°C	M : ±20						
Dissipation Factor (DF)	120Hz/20°C	0.35	0.30	0.26	0.20	0.16	0.12	
Leakage current (LC)	μA/after 2minutes (max)	The greater value of either 0.01CV or 3						
Impedance ratio at low temperature	Based the value at 120Hz, +20°C	-25°C Z/Z _{20°C}	4	3	2	2	2	2
		-40°C Z/Z _{20°C}	10	8	6	4	4	4
Endurance	105°C, 1,000hrs rated voltage applied (With the rated ripple current)	ΔC/C	Within ±25% of the initial value(6.3VV:±30%)					
		tan δ	≤ 3 times the initial specified value					
		LC	≤ The initial specified value					

Marking, Dimensions

(単位 : mm)

Polarity (Cathode)

D ^{+0.5max}	L ^{+0.1 -0.2}	W ^{±0.2}	H ^{±0.2}	C ^{±0.2}	R	P ^{±0.2}
4	5.4	4.3	4.3	5.0	0.5 to 0.8	1.0
5	5.4	5.3	5.3	6.0	0.5 to 0.8	1.4
6.3	5.4	6.6	6.6	7.3	0.5 to 0.8	2.2

Size List, Rated Ripple Current

μF \ V	6.3	10	16	25	35	50
4.7						4 x 5.4 16
10				4 x 5.4 22	4 x 5.4 22	5 x 5.4 23
22		4 x 5.4 28	4 x 5.4 28	5 x 5.4 35	5 x 5.4 35	6.3 x 5.4 35
33	4 x 5.4 29	4 x 5.4 29	5 x 5.4 35	5 x 5.4 45	6.3 x 5.4 42	
47	5 x 5.4 36	5 x 5.4 43	5 x 5.4 39	6.3 x 5.4 70		
100	5 x 5.4 47	5 x 5.4 47				
150	6.3 x 5.4 71	6.3 x 5.4 71				
220	6.3 x 5.4 74					

Please refer to page 16 for the ripple current frequency coefficient.

Case size ; φ D x L (mm)

Rated ripple current
mA_{rms} (120Hz, 105°C)

Model No. 16 CE 47 FSS

- Series code
- Rated capacitance code
- Type code
- Rated voltage

CE-FS Series

105°C Standard
Mid. and High Voltage



- 160 to 400V 105°C, 1,000 to 2,000hrs
- Do not clean the capacitors using solvent.

Specifications

Items	Condition	Specifications				
Rated voltage (V)	—	160	200	250	400	
Surge voltage (V)	Room temperature	200	250	300	450	
Category temperature range (°C)	—	-40 to +105				
Capacitance tolerance (%)	120Hz/20°C	M : ±20				
Dissipation Factor (DF)	120Hz/20°C	0.20			0.25	
Leakage current (LC)	μ A/after 2minutes (max)	CV ≤ 1,000	0.03CV + 15			
		CV > 1,000	0.02CV + 25			
Impedance ratio at low temperature	Based the value at 120Hz, +20°C	-25°C Z/Z _{20°C}	3	3	3	6
		-40°C Z/Z _{20°C}	6	6	6	10
Endurance	105°C rated voltage applied (With the rated ripple current)	Test	φ 8 : 1,000hrs., φ 10 to φ 16 : 2,000hrs.			
		ΔC/C	Within ±25% of the initial value			
		tan δ	≤ 2 times the initial specified value			
		LC	≤ The initial specified value			

Marking, Dimensions

[φD≤10]
Polarity (Cathode)
Lot No.
80
10
200F
Rated Capacity
Series Symbol
Rated Voltage

[φD≥12.5]
Polarity (Cathode)
Lot No.
80T
47
200F
Indicated Only φD=16
Rated Capacity
Series Symbol
Rated Voltage

0.3max

pressure relief vent

(Unit : mm)

D ^{+0.5max}	L ^{+0.3}	W ^{+0.2}	H ^{+0.2}	C ^{+0.2}	R	P ^{+0.2}
8	10.5	8.3	8.3	9.0	0.7 to 1.0	3.2
10	10.5	10.3	10.3	11.0	1.0 to 1.4	4.6
12.5	13.5 ^{+0.5}	12.8	12.8	13.5	1.0 to 1.4	4.6
16	16.5 ^{+0.5}	16.3	16.3	17.3	1.8 to 2.1	7.0

Size List, Rated Ripple Current

μF	160		200		250		400	
2.2							8 x 10.5	25
3.3					8 x 10.5	31	10 x 10.5	36
4.7					8 x 10.5	37	10 x 10.5	38
6.8					8 x 10.5	44	12.5 x 13.5	47
10	8 x 10.5	57	10 x 10.5	64	10 x 10.5	64	12.5 x 13.5	57
22	12.5 x 13.5	112	12.5 x 13.5	112	12.5 x 13.5	112	16 x 16.5	115
33	12.5 x 13.5	137	12.5 x 13.5	137	16 x 16.5	150		
47	16 x 16.5	180	16 x 16.5	180	16 x 16.5	180		
68	16 x 16.5	215	16 x 16.5	215				
82	16 x 16.5	235						

Please refer to page 16 for the ripple current frequency coefficient.

Case size ; φ D x L (mm)
16 x 16.5 ; CE-FST series

Rated ripple current
mAmps (120Hz, 105°C)

Model No.

200 CE 10 FS
Series code
Rated capacitance code
Type code
Rated voltage

200 CE 47 FST
Series code
Rated capacitance code
Type code
Rated voltage

CE-FS Series

105°C Standard



- 105°C, 1,000 to 2,000hrs
- Solvent proof (within 2 minutes)

Specifications

Items	Condition	Specifications									
Rated voltage (V)	—	6.3	10	16	25	35	50	63	100		
Surge Voltage (V)	Room temperature	8.0	13	20	32	44	63	79	125		
Category temperature range (°C)	—	-55 to +105								-40 to +105	
Capacitance tolerance (%)	120Hz/20°C	M : ±20									
Dissipation Factor (DF)	120Hz/20°C	φ 4 to φ 6.3	0.24	0.20	0.16	0.14	0.12	0.10	0.12	0.10	
		φ 8 to φ 16	0.28	0.24	0.20	0.16	0.14	0.12	0.12	0.10	
		When rated capacitance exceeds 1,000 μF, add 0.02 to the value above for each 1,000 μF increase.									
Leakage current (LC)	μA/after 2minutes (max)	The greater value of either 0.01CV or 3									
Impedance ratio at low temperature	Based the value at 120Hz, +20°C	-40°C Z/Z _{20°C}	3	3	2	2	2	2	2	3	
		-55°C Z/Z _{20°C}	8	5	4	3	3	3	3	—	
Endurance	105°C rated voltage applied (With the rated ripple current)	Test	φ 4 to φ 6.3, φ 10 × 7.7 : 1,000hrs., φ 8 to φ 16 : 2,000hrs.								
		ΔC/C	Within ±25% of the initial value								
		tan δ	≤ 2 times the initial specified value								
		LC	≤ The initial specified value								

Marking, Dimensions

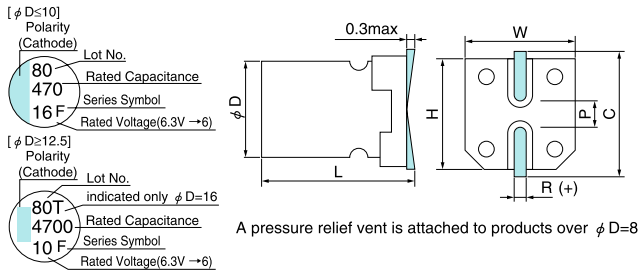

D ^{+0.5max}	L	W ^{±0.2}	H ^{±0.2}	C ^{±0.2}	R	P ^{+0.2}
4	5.4 ^{+0.1} _{-0.2}	4.3	4.3	5.0	0.5 to 0.8	1.0
5	5.4 ^{+0.1} _{-0.2}	5.3	5.3	6.0	0.5 to 0.8	1.4
6.3	5.4 ^{+0.1} _{-0.2}	6.6	6.6	7.3	0.5 to 0.8	2.2
4	6.0 ^{±0.3}	4.3	4.3	5.0	0.5 to 0.8	1.0
6.3	6.0 ^{±0.3}	6.6	6.6	7.3	0.5 to 0.8	2.2
6.3	7.7 ^{±0.3}	6.6	6.6	7.3	0.5 to 0.8	2.2
8	10.2 ^{±0.3}	8.3	8.3	9.0	0.7 to 1.0	3.2
10	7.7 ^{±0.3}	10.3	10.3	11.0	1.0 to 1.4	4.6
10	10.2 ^{±0.3}	10.3	10.3	11.0	1.0 to 1.4	4.6
12.5	13.5 ^{±0.5}	12.8	12.8	13.5	1.0 to 1.4	4.6
16	16.5 ^{±0.5}	16.3	16.3	17.3	1.8 to 2.1	7.0

SMD Type

CE-FS Series

Size List, Rated Ripple Current

μF \ V	6.3		10		16		25		35		50		63		100	
0.10 to 0.47											4 x 5.4	0.7 to 3.5	4 x 5.4	0.7 to 3.5		
1.0											4 x 5.4	7	4 x 5.4	7	4 x 6.0	7
2.2											4 x 5.4	11	4 x 5.4	11	6.3 x 6.0	14
3.3											4 x 5.4	13	5 x 5.4	14	6.3 x 6.0	20
4.7							4 x 5.4	13	4 x 5.4	14	5 x 5.4	16	5 x 5.4	16	6.3 x 6.0	25
10					4 x 5.4	18	5 x 5.4	20	5 x 5.4	21	6.3 x 5.4	24	6.3 x 5.4	24	6.3 x 7.7	35
22	4 x 5.4	22	5 x 5.4	25	5 x 5.4	27	6.3 x 5.4	36	6.3 x 5.4	38	6.3 x 6.0	42	6.3 x 7.7	49	8 x 10.2	84
33	5 x 5.4	27	5 x 5.4	30	6.3 x 5.4	40	6.3 x 5.4	44	6.3 x 6.0	42	6.3 x 7.7	60	8 x 10.2	112	10 x 10.2	133
47	5 x 5.4	33	6.3 x 5.4	41	6.3 x 5.4	48	6.3 x 6.0	48	6.3 x 6.0	49	6.3 x 7.7	63	8 x 10.2	119	12.5 x 13.5	240
68													8 x 10.2	126	12.5 x 13.5	245
82											10 x 7.7	140				
100	6.3 x 5.4	50	6.3 x 5.4	53	6.3 x 5.4	60	6.3 x 7.7	91	6.3 x 7.7	84	8 x 10.2	140	10 x 10.2	196	16 x 16.5	490
150			6.3 x 6.0	62	6.3 x 7.7	95	8 x 10.2	140	8 x 10.2	155					16 x 16.5	500
220	6.3 x 6.0	67	6.3 x 7.7	105	6.3 x 7.7	105	8 x 10.2	175	8 x 10.2	190	10 x 10.2	220	12.5 x 13.5	287		
330	6.3 x 7.7	105	8 x 10.2	195	8 x 10.2	195	8 x 10.2	220	10 x 10.2	300	12.5 x 13.5	365				
390					10 x 7.7	195										
470	8 x 10.2	210	8 x 10.2	210	8 x 10.2	230	10 x 10.2	300	12.5 x 13.5	410			16 x 16.5	630		
680	8 x 10.2	210			10 x 10.2	310			12.5 x 13.5	430						
1000	8 x 10.2	230	10 x 10.2	310			12.5 x 13.5	460	16 x 16.5	700	16 x 16.5	655				
1500	10 x 10.2	310			12.5 x 13.5	500			16 x 16.5	740						
2200			12.5 x 13.5	510			16 x 16.5	805								
3300	12.5 x 13.5	520			16 x 16.5	840										
4700			16 x 16.5	880												
6800	16 x 16.5	930														

Please refer to page 16 for the ripple current frequency coefficient.

Case size ; ϕ D x L (mm)
 10 x 7.7 ; CE-FSA series
 16 x 16.5 ; CE-FST series

Rated ripple current
 mA rms (120Hz, 105°C)

Model No.

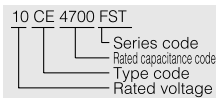
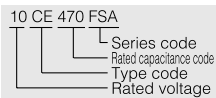
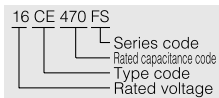

CE-FH Series

Long Life



- 105°C, 2,000 to 5,000hrs
- Solvent proof (within 2 minutes)

Specifications

Items	Condition	Specifications						
Rated voltage (V)	—	6.3	10	16	25	35	50	
Surge voltage (V)	Room temperature	8.0	13	20	32	44	63	
Category temperature range (°C)	—	-40 to +105						
Capacitance tolerance (%)	120Hz/20°C	M : ±20						
Dissipation Factor (DF)	120Hz/20°C	0.30	0.24	0.20	0.16	0.14	0.14	
		When rated capacitance exceeds 1,000 μF, add 0.02 to the value above for each 1,000 μF increase.						
Leakage current (LC)	μA/after 2minutes (max)	The greater value of either 0.01CV or 3						
Impedance ratio at low temperature	Based the value at 120Hz, +20°C	-25°C Z/Z _{20°C}	4	3	2	2	2	2
		-40°C Z/Z _{20°C}	8	6	4	4	3	3
Endurance	105°C rated voltage applied (With the rated ripple current)	Test	φ 4 to φ 6.3 : 2,000hrs., φ 8 to φ 10 : 3,000hrs., φ 12.5 to φ 16 : 5,000hrs.					
		ΔC/C	Within ±25% of the initial value					
		tan δ	≤ 2.5 times the initial specified value					
		LC	≤ The initial specified value					

Marking, Dimensions

(Unit : mm)

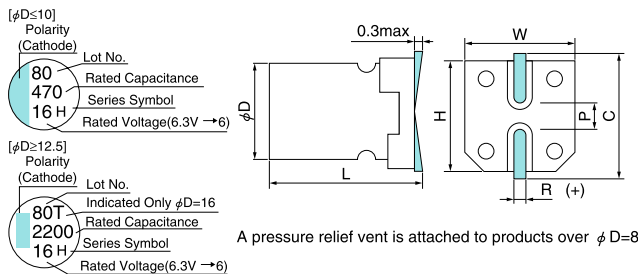

D ^{+0.5max}	L ^{+0.3}	W ^{+0.2}	H ^{+0.2}	C ^{-0.2}	R	P ^{+0.2}
4	6.0	4.3	4.3	5.0	0.5 to 0.8	1.0
5	6.0	5.3	5.3	6.0	0.5 to 0.8	1.4
6.3	6.0	6.6	6.6	7.3	0.5 to 0.8	2.2
6.3	7.7	6.6	6.6	7.3	0.5 to 0.8	2.2
8	10.2	8.3	8.3	9.0	0.7 to 1.0	3.2
10	10.2	10.3	10.3	11.0	1.1 to 1.4	4.6
12.5	13.5 ^{+0.5}	12.8	12.8	13.5	1.1 to 1.4	4.6
16	16.5 ^{+0.5}	16.3	16.3	17.3	1.8 to 2.1	7.0

Size List, Rated Ripple Current

μF	6.3	10	16	25	35	50
0.10						4 x 6.0 0.7
0.22						4 x 6.0 1.6
0.33						4 x 6.0 2.5
0.47						4 x 6.0 3.5
1.0						4 x 6.0 7
2.2						4 x 6.0 11
3.3						4 x 6.0 13
4.7				4 x 6.0 13	4 x 6.0 15	5 x 6.0 19
10			4 x 6.0 18	5 x 6.0 23	5 x 6.0 25	6.3 x 6.0 32
22	4 x 6.0 22	5 x 6.0 27	5 x 6.0 30	6.3 x 6.0 42	6.3 x 6.0 44	6.3 x 7.7 60
33	5 x 6.0 30	5 x 6.0 35	6.3 x 6.0 44	6.3 x 6.0 58	6.3 x 7.7 77	8 x 10.2 140
47	5 x 6.0 36	6.3 x 6.0 46	6.3 x 6.0 60	6.3 x 7.7 91	8 x 10.2 150	8 x 10.2 150
100	6.3 x 6.0 67	6.3 x 6.0 62	6.3 x 7.7 95	8 x 10.2 150	8 x 10.2 160	10 x 10.2 220
220	6.3 x 7.7 105	8 x 10.2 175	8 x 10.2 175	8 x 10.2 195	10 x 10.2 290	12.5 x 13.5 340
330	8 x 10.2 195	8 x 10.2 195	8 x 10.2 210	10 x 10.2 290	12.5 x 13.5 380	
470	8 x 10.2 210	8 x 10.2 210	10 x 10.2 290	12.5 x 13.5 400		16 x 16.5 610
680		10 x 10.2 300		12.5 x 13.5 415		
1000	10 x 10.2 300		12.5 x 13.5 440		16 x 16.5 620	
1500		12.5 x 13.5 480		16 x 16.5 720		
2200	12.5 x 13.5 490		16 x 16.5 785			
3300		16 x 16.5 820				
4700	16 x 16.5 860					

Please refer to page 16 for the ripple current frequency coefficient.

Model No.

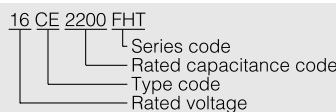
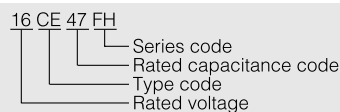

Case size ; φ D x L (mm)
16 x 16.5 : CE-FHT series

Rated ripple current
mA rms (120Hz, 105°C)

CE-GA Series

Low Impedance

5.4mm Height



- 105°C, 1,000hrs
- Solvent proof (within 2 minutes)

Specifications

Items	Condition	Specifications							
Rated voltage (V)	—	6.3	10	16	25	35	50	63	
Surge voltage (V)	Room temperature	8.0	13	20	32	44	63	79	
Category temperature range (°C)	—	-55 to +105							
Capacitance tolerance (%)	120Hz/20°C	M : ±20							
Dissipation Factor (DF)	120Hz/20°C	0.24	0.20	0.16	0.14	0.12	0.12	0.12	
Leakage current (LC)	μA/after 2minutes (max)	The greater value of either 0.01CV or 3							
Impedance ratio at low temperature	Based the value at 120Hz, +20°C	-40°C Z/Z _{20°C}	3	2	2	2	2	2	2
		-55°C Z/Z _{20°C}	5	4	4	3	3	3	3
Endurance	105°C, 1,000hrs. rated voltage applied (With the rated ripple current)	ΔC/C	Within ±25% of the initial value						
		tan δ	≤ 2 times the initial specified value						
		LC	≤ The initial specified value						

Marking, Dimensions

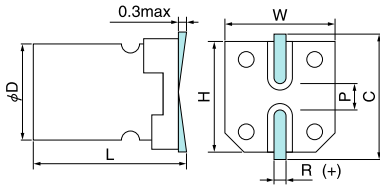
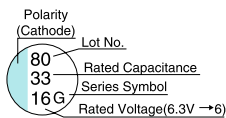

(Unit : mm)

D ^{+0.5max}	L ^{+0.1 -0.2}	W ^{+0.2}	H ^{+0.2}	C ^{+0.2}	R	P ^{+0.2}
4	5.4	4.3	4.3	5.0	0.5 to 0.8	1.0
5	5.4	5.3	5.3	6.0	0.5 to 0.8	1.4
6.3	5.4	6.6	6.6	7.3	0.5 to 0.8	2.2

Size List, Impedance, Rated Ripple Current

μF	V		6.3		10		16		25		35		50		63					
	4	5	4	5	4	5	4	5	4	5	4	5	4	5	4	5				
0.47											4	6.0	51	4	8.0	30	4	10	15	
1.0											4	3.1	68	4	7.4	37	4	8.0	20	
2.2											4	2.9	68	4	6.6	45	4	8.0	24	
3.3											4	2.7	68	4	5.4	52	5	3.5	40	
4.7									4	2.3	68	4	2.3	68	5	2.9	75	5	3.5	40
10					4	2.3	68	5	1.1	105	5	1.1	105	6.3	1.3	120	6.3	1.6	65	
22	4	2.3	68	5	1.1	105	5	1.1	105	6.3	0.6	155	6.3	0.6	155					
33	5	1.1	105	5	1.1	105	6.3	0.6	155	6.3	0.6	155								
47	5	1.1	105	6.3	0.6	155	6.3	0.6	155	6.3	0.6	155								
100	6.3	0.6	155	6.3	0.6	155	6.3	0.6	155											

Please refer to page 16 for the ripple current frequency coefficient.

Case size ; φ D (mm)
Impedance (Ω)
max at 100kHz, 20°C
Rated ripple current
mA rms (100kHz, 105°C)

Model No.

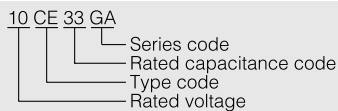

CE-AX Series

Low Impedance



- 105°C, 1,000 to 2,000hrs
- Solvent proof (within 2 minutes)

Specifications

Items	Condition	Specifications						
Rated voltage (V)	—	6.3	10	16	25	35	50	
Surge voltage (V)	Room temperature	8.0	13	20	32	44	63	
Category temperature range (°C)	—	-55 to +105						
Capacitance tolerance (%)	120Hz/20°C	M : ±20						
Dissipation Factor (DF)	120Hz/20°C	φ 4 to φ 6.3	0.24	0.20	0.16	0.14	0.12	0.12
		φ 8 to φ 16	0.28	0.24	0.20	0.16	0.14	0.14
Leakage current (LC)	μA/after 2minutes (max)	When rated capacitance exceeds 1,000 μF, add 0.02 to the value above for each 1,000 μF increase.						
Impedance ratio at low temperature	Based the value at 120Hz, +20°C	-40°C Z/Z _{20°C}	3	2	2	2	2	2
		-55°C Z/Z _{20°C}	5	4	4	3	3	3
Endurance	105°C rated voltage applied (With the rated ripple current)	Test	φ 4 to φ 6.3, φ 10×7.7 : 1,000hrs., φ 8 to φ 16 : 2,000hrs.					
		ΔC/C	Within ±25% of the initial value					
		tan δ	≤ 2 times the initial specified value					
		LC	≤ The initial specified value					

Marking, Dimensions

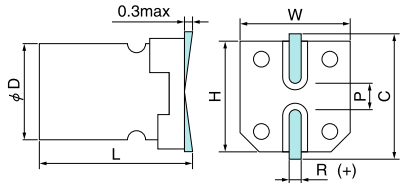
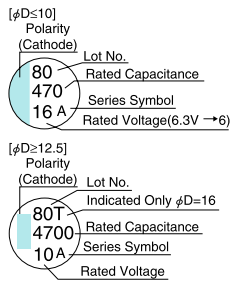

(Unit : mm)

D ^{+0.5max}	L ^{±0.3}	W ^{±0.2}	H ^{±0.2}	C ^{±0.2}	R	P ^{±0.2}
4	6.0	4.3	4.3	5.0	0.5 to 0.8	1.0
5	6.0	5.3	5.3	6.0	0.5 to 0.8	1.4
6.3	6.0	6.6	6.6	7.3	0.5 to 0.8	2.2
6.3	7.7	6.6	6.6	7.3	0.5 to 0.8	2.2
8	10.2	8.3	8.3	9.0	0.7 to 1.0	3.2
10	7.7	10.3	10.3	11.0	1.0 to 1.4	4.6
10	10.2	10.3	10.3	11.0	1.0 to 1.4	4.6
12.5	13.5 ^{±0.5}	12.8	12.8	13.5	1.0 to 1.4	4.6
16	16.5 ^{±0.5}	16.3	16.3	17.3	1.8 to 2.1	7.0

SMD Type

CE-AX Series

Size List, Impedance, Rated Ripple Current

μF \ V	6.3		10		16		25		35		50							
4.7									4 x 6.0	1.80	80	4 x 6.0	2.90	60				
10							4 x 6.0	1.80	80	5 x 6.0	0.76	150	6.3 x 6.0	0.88	165			
15						4 x 6.0	1.80	80	5 x 6.0	0.76	150	5 x 6.0	0.76	150				
22				4 x 6.0	1.80	80	5 x 6.0	0.76	150	5 x 6.0	0.76	150	5 x 6.0	0.76	150	6.3 x 6.0	0.88	165
27	4 x 6.0	1.80	80															
33		→		5 x 6.0	0.76	150		→		6.3 x 6.0	0.44	230	6.3 x 6.0	0.44	230	6.3 x 7.7	0.68	195
47	5 x 6.0	0.76	150		→		6.3 x 6.0	0.44	230	6.3 x 6.0	0.44	230	6.3 x 6.0	0.44	230	6.3 x 7.7	0.68	195
56	5 x 6.0	0.76	150							6.3 x 6.0	0.44	230						
68		→		6.3 x 6.0	0.44	230	6.3 x 6.0	0.44	230	6.3 x 6.0	0.44	230	6.3 x 7.7	0.34	280			
100	6.3 x 6.0	0.44	230		→		6.3 x 6.0	0.44	230	6.3 x 7.7	0.34	280	8 x 10.2	0.17	450	8 x 10.2	0.39	300
150	6.3 x 6.0	0.44	230	6.3 x 6.0	0.44	230	6.3 x 7.7	0.34	280	8 x 10.2	0.17	450	8 x 10.2	0.17	450	10 x 10.2	0.21	450
										→		10 x 7.7	0.17	450				
220	6.3 x 6.0	0.44	230	6.3 x 7.7	0.34	280	6.3 x 7.7	0.34	280	8 x 10.2	0.17	450	8 x 10.2	0.17	450	10 x 10.2	0.21	450
										10 x 7.7	0.17	450						
330	6.3 x 7.7	0.34	280	8 x 10.2	0.17	450	8 x 10.2	0.17	450	8 x 10.2	0.17	450	10 x 10.2	0.09	670	12.5 x 13.5	0.14	620
					→		10 x 7.7	0.17	450									
390																12.5 x 13.5	0.14	620
470	8 x 10.2	0.17	450	8 x 10.2	0.17	450	8 x 10.2	0.17	450	10 x 10.2	0.09	670	12.5 x 13.5	0.066	900			
				10 x 7.7	0.17	450												
680	8 x 10.2	0.17	450		→		10 x 10.2	0.09	670				12.5 x 13.5	0.066	900			
	10 x 7.7	0.17	450															
1000	8 x 10.2	0.17	450	10 x 10.2	0.09	670				12.5 x 13.5	0.066	900				16 x 16.5	0.078	790
1500	10 x 10.2	0.09	670				12.5 x 13.5	0.066	900				16 x 16.5	0.052	1250			
2200				12.5 x 13.5	0.066	900				16 x 16.5	0.052	1250						
3300	12.5 x 13.5	0.066	900				16 x 16.5	0.052	1250									
4700				16 x 16.5	0.052	1250												
6800	16 x 16.5	0.052	1250															

→ Use next higher voltage product.

Please refer to page 16 for the ripple current frequency coefficient.

Case size ; ϕ D x L (mm)
 10 x 7.7 ; CE-AXA series
 16 x 16.5 ; CE-AXT series

Rated ripple current
 mA rms (100kHz, 105°C)

Impedance (Ω)
 max at 100kHz, 20°C

Model No.

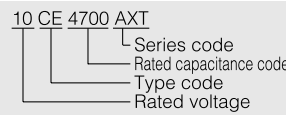
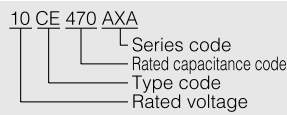
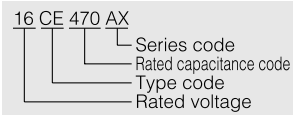

CE-KX Series

Low Impedance



- This series has 10 to 20% less impedance with same package than CE-AX series.
- 105°C, 1,000 to 2,000hrs, Solvent proof (within 2 minutes)

Specifications

Items	Condition	Specifications									
Rated voltage (V)	—	6.3	10	16	25	35	50	63	80	100	
Surge voltage (V)	Room temperature	8.0	13	20	32	44	63	79	100	125	
Category temperature range (°C)	—	-55 to +105									
Capacitance tolerance (%)	120Hz/20°C	M : ±20									
Dissipation Factor (DF)	120Hz/20°C	φ 4 to φ 6.3	0.24	0.20	0.16	0.14	0.12	0.12	0.10	0.08	0.07
		φ 8 to φ 16	0.28	0.24	0.20	0.16	0.14	0.14	0.12	0.10	0.08
		When rated capacitance exceeds 1,000 μF, add 0.02 to the value above for each 1,000 μF increase.									
Leakage current (LC)	μA/after 2minutes (max)	The greater value of either 0.01CV or 3									
Impedance ratio at low temperature	Based the value at 120Hz, +20°C	-40°C Z/Z _{20°C}	3	2	2	2	2	2	2	2	2
		-55°C Z/Z _{20°C}	5	4	4	3	3	3	3	3	3
Endurance	105°C rated voltage applied (With the rated ripple current)	Test	φ 4 to φ 6.3 : 1,000hrs., φ 8 to φ 16 : 2,000hrs.								
		ΔC/C	Within ±25% of the initial value								
		tan δ	≤ 2 times the initial specified value								
		LC	≤ The initial specified value								

Marking, Dimensions

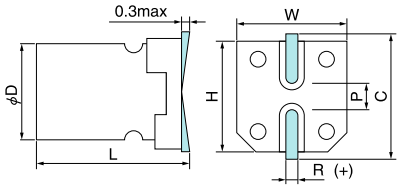
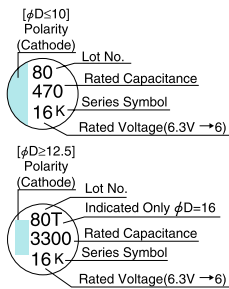

A pressure relief vent is attached to products over φ D=8

(Unit : mm)

D _{±0.5max}	L _{±0.3}	W _{±0.2}	H _{±0.2}	C _{±0.2}	R	P _{±0.2}
4	6.0	4.3	4.3	5.0	0.5 to 0.8	1.0
5	6.0	5.3	5.3	6.0	0.5 to 0.8	1.4
6.3	6.0	6.6	6.6	7.3	0.5 to 0.8	2.2
6.3	7.7	6.6	6.6	7.3	0.5 to 0.8	2.2
8	10.2	8.3	8.3	9.0	0.7 to 1.0	3.2
10	10.2	10.3	10.3	11.0	1.0 to 1.4	4.6
12.5	13.5 ^{±0.5}	12.8	12.8	13.5	1.0 to 1.4	4.6
16	16.5 ^{±0.5}	16.3	16.3	17.3	1.8 to 2.1	7.0

Size List, Impedance, Rated Ripple Current

μF \ V	6.3	10	16	25	35	50	63	80	100
4.7					4x6.0 1.45 90	4x6.0 2.55 64	5x6.0 2.00 55	6.3x6.0 2.40 45	
10				4x6.0 1.45 90	5x6.0 0.70 170	6.3x6.0 0.52 215	6.3x6.0 1.00 90	6.3x7.7 2.00 65	
15			4x6.0 1.45 90	5x6.0 0.70 170	5x6.0 0.70 170				
22		4x6.0 1.45 90	5x6.0 0.70 170	5x6.0 0.70 170	5x6.0 0.70 170	6.3x6.0 0.52 215	6.3x7.7 0.80 135	8x10.2 0.90 140	8x10.2 0.90 140
27	4x6.0 1.45 90								
33	→	5x6.0 0.70 170	→	6.3x6.0 0.39 250	6.3x6.0 0.39 250	6.3x7.7 0.44 243	8x10.2 0.35 280	8x10.2 0.90 140	10x10.2 0.50 220
47	5x6.0 0.70 170	→	6.3x6.0 0.39 250	6.3x6.0 0.39 250	6.3x6.0 0.39 250	6.3x7.7 0.44 243	8x10.2 0.35 280	10x10.2 0.50 220	12.5x13.5 0.24 500
56	5x6.0 0.70 170		6.3x6.0 0.39 250	6.3x6.0 0.39 250					
68	→	6.3x6.0 0.39 250	6.3x6.0 0.39 250	6.3x6.0 0.39 250	6.3x7.7 0.30 300				
100	6.3x6.0 0.39 250	→	6.3x6.0 0.39 250	6.3x7.7 0.30 300	8x10.2 0.15 600	8x10.2 0.22 400	10x10.2 0.20 480	12.5x13.5 0.24 500	16x16.5 0.14 800
150	6.3x6.0 0.39 250	6.3x6.0 0.39 250	6.3x7.7 0.30 300	8x10.2 0.15 600	8x10.2 0.15 600			12.5x13.5 0.24 500	16x16.5 0.14 800
220	6.3x6.0 0.39 250	6.3x7.7 0.30 300	6.3x7.7 0.30 300	8x10.2 0.15 600	8x10.2 0.15 600	10x10.2 0.13 585	12.5x13.5 0.14 800		
330	6.3x7.7 0.30 300	8x10.2 0.15 600	8x10.2 0.15 600	8x10.2 0.15 600	10x10.2 0.08 850	12.5x13.5 0.10 800		16x16.5 0.14 800	
470	8x10.2 0.15 600	8x10.2 0.15 600	8x10.2 0.15 600	10x10.2 0.08 850	12.5x13.5 0.058 1150		16x16.5 0.065 1410		
680	8x10.2 0.15 600	→	10x10.2 0.08 850		12.5x13.5 0.058 1150				
1000	8x10.2 0.15 600	10x10.2 0.08 850		12.5x13.5 0.058 1150	16x16.5 0.035 1800	16x16.5 0.060 1610			
1500	10x10.2 0.08 850		12.5x13.5 0.058 1150		16x16.5 0.035 1800				
2200		12.5x13.5 0.058 1150		16x16.5 0.035 1800					
3300	12.5x13.5 0.058 1150		16x16.5 0.035 1800						
4700		16x16.5 0.035 1800							
6800	16x16.5 0.035 1800								

→ Use next higher voltage product.

Please refer to page 16 for the ripple current frequency coefficient.

Case size ; ϕ D x L (mm)
16 x 16.5 ; CE-KXT series

Rated ripple current
mA rms (100kHz, 105°C)

Impedance (Ω)
max at 100kHz, 20°C

Model No.

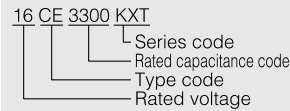
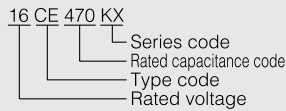

CE-LX Series

Low Impedance

Long Life



- 105°C, 2,000 to 5,000hrs
- Solvent proof (within 2 minutes)

Specifications

Items	Condition	Specifications									
Rated voltage (V)	—	6.3	10	16	25	35	50	60	100		
Surge voltage (V)	Room temperature	8.0	13	20	32	44	63	79	125		
Category temperature range (°C)	—	-55 to +105									
Capacitance tolerance (%)	120Hz/20°C	M : ±20									
Dissipation Factor (DF)	120Hz/20°C	φ 4 to φ 6.3	0.26	0.20	0.16	0.14	0.12	0.12	—	—	
		φ 8 to φ 16	0.28	0.24	0.22	0.16	0.14	0.14	0.08	0.07	
Leakage current (LC)	μA/after 2minutes (max)	When rated capacitance exceeds 1,000 μF, add 0.02 to the value above for each 1,000 μF increase.									
Impedance ratio at low temperature	Based the value at 120Hz, +20°C	The greater value of either 0.01CV or 3									
Endurance	105°C rated voltage applied (With the rated ripple current)	Test	φ 4 to φ 6.3 : 2,000hrs., φ 8 to φ 16 : 5,000hrs.								
		ΔC/C	Within ±30% of the initial value								
		tan δ	≤ 3 times the initial specified value								
		LC	≤ The initial specified value								

Marking, Dimensions

[φD≤10]
Polarity (Cathode)
Lot No.
80
470
16 L
Rated Capacity
Series Symbol
Rated Voltage(6.3V →6)

[φD≥12.5]
Polarity (Cathode)
Lot No.
80T
3300
16 L
Indicated Only φD=16
Rated Capacity
Series Symbol
Rated Voltage(6.3V →6)

A pressure relief vent is attached to products over φ D=8

(Unit : mm)

D ^{+0.5max}	L ^{±0.3}	W ^{±0.2}	H ^{±0.2}	C ^{±0.2}	R	P ^{±0.2}
4	6.0	4.3	4.3	5.0	0.5 to 0.8	1.0
5	6.0	5.3	5.3	6.0	0.5 to 0.8	1.4
6.3	6.0	6.6	6.6	7.3	0.5 to 0.8	2.2
6.3	7.7	6.6	6.6	7.3	0.5 to 0.8	2.2
8	10.2	8.3	8.3	9.0	0.7 to 1.0	3.2
10	10.2	10.3	10.3	11.0	1.0 to 1.4	4.6
12.5	13.5 ^{±0.5}	12.8	12.8	13.5	1.0 to 1.4	4.6
16	16.5 ^{±0.5}	16.3	16.3	17.3	1.8 to 2.1	7.0

Size List, Impedance, Rated Ripple Current

μF \ V	6.3	10	16	25	35	50	63	100
4.7					4 x 6.0 1.45 90	4 x 6.0 2.9 60		
10				4 x 6.0 1.45 90	5 x 6.0 0.70 170	6.3 x 6.0 0.88 165		
15			4 x 6.0 1.45 90	5 x 6.0 0.70 170	5 x 6.0 0.70 170	6.3 x 6.0 0.88 165		
22		4 x 6.0 1.45 90	5 x 6.0 0.70 170	5 x 6.0 0.70 170	5 x 6.0 0.70 170	6.3 x 6.0 0.88 165		
27	4 x 6.0 1.45 90	5 x 6.0 0.70 170	5 x 6.0 0.70 170	6.3 x 6.0 0.39 250	6.3 x 6.0 0.39 250	6.3 x 7.7 0.68 195		
33	5 x 6.0 0.70 170	5 x 6.0 0.70 170	6.3 x 6.0 0.39 250	6.3 x 6.0 0.39 250	6.3 x 6.0 0.39 250	6.3 x 7.7 0.68 195		10 x 10.2 0.65 200
47	5 x 6.0 0.70 170	6.3 x 6.0 0.39 250	6.3 x 6.0 0.39 250	6.3 x 6.0 0.39 250	6.3 x 6.0 0.39 250	6.3 x 7.7 0.68 195		12.5 x 13.5 0.32 500
56	5 x 6.0 0.70 170	6.3 x 6.0 0.39 250	6.3 x 6.0 0.39 250	6.3 x 6.0 0.39 250	6.3 x 7.7 0.30 300	8 x 10.2 0.34 300		
68	6.3 x 6.0 0.39 250	6.3 x 6.0 0.39 250	6.3 x 6.0 0.39 250	6.3 x 6.0 0.39 250	6.3 x 7.7 0.30 300	8 x 10.2 0.34 300		12.5 x 13.5 0.32 500
100	6.3 x 6.0 0.39 250	6.3 x 6.0 0.39 250	6.3 x 6.0 0.39 250	6.3 x 7.7 0.30 300	8 x 10.2 0.17 450	8 x 10.2 0.34 300		16 x 16.5 0.17 793
150	6.3 x 6.0 0.39 250	6.3 x 6.0 0.39 250	6.3 x 7.7 0.30 300	8 x 10.2 0.17 450	8 x 10.2 0.17 450	10 x 10.2 0.18 490	12.5 x 13.5 0.16 580	16 x 16.5 0.17 793
220	6.3 x 6.0 0.39 250	6.3 x 7.7 0.30 300	6.3 x 7.7 0.30 300	8 x 10.2 0.17 450	8 x 10.2 0.17 450	10 x 10.2 0.18 490	12.5 x 13.5 0.16 580	
330	6.3 x 7.7 0.30 300	8 x 10.2 0.17 450	8 x 10.2 0.17 450	8 x 10.2 0.17 450	10 x 10.2 0.090 670	12.5 x 13.5 0.12 620		
470	8 x 10.2 0.17 450	8 x 10.2 0.17 450	8 x 10.2 0.17 450	10 x 10.2 0.090 670	12.5 x 13.5 0.060 900	16 x 16.5 0.073 1610	16 x 16.5 0.082 1410	
680	8 x 10.2 0.17 450	10 x 10.2 0.090 670	10 x 10.2 0.090 670	12.5 x 13.5 0.060 900	12.5 x 13.5 0.060 900	16 x 16.5 0.073 1610		
1000	8 x 10.2 0.17 450	10 x 10.2 0.090 670	12.5 x 13.5 0.060 900	12.5 x 13.5 0.060 900	16 x 16.5 0.035 1800	16 x 16.5 0.073 1610		
1500	10 x 10.2 0.090 670	12.5 x 13.5 0.060 900	12.5 x 13.5 0.060 900	16 x 16.5 0.035 1800	16 x 16.5 0.035 1800			
2200	12.5 x 13.5 0.060 900	12.5 x 13.5 0.060 900		16 x 16.5 0.035 1800				
3300			16 x 16.5 0.035 1800					
4700		16 x 16.5 0.035 1800						
6800	16 x 16.5 0.035 1800							

Please refer to page 16 for the ripple current frequency coefficient.

Case size ; ϕ D x L (mm)
16 x 16.5; CE-LXT series

Rated ripple current
mArms (100kHz, 105°C)

Impedance (Ω)
max at 100kHz, 20°C

Model No.

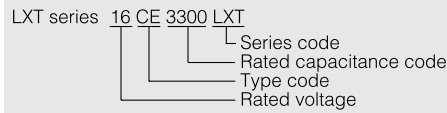
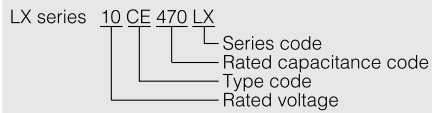

CE-LS Series

Low Impedance

Long Life



- 105°C, 3,000hrs
- Solvent proof (within 2 minutes)

Specifications

Items	Condition	Specifications						
Rated voltage (V)	—	6.3	10	16	25	35	50	
Surge voltage (V)	Room temperature	8.0	13	20	32	44	63	
Category temperature range (°C)	—	-40 to +105						
Capacitance tolerance (%)	120Hz/20°C	M : ±20						
Dissipation Factor (DF)	120Hz/20°C	0.28	0.24	0.22	0.16	0.13	0.12	
Leakage current (LC)	μA/after 2minutes (max)	The greater value of either 0.01CV or 3						
Impedance ratio at low temperature	Based the value at 120Hz, +20°C	-25°C Z/Z _{20°C}	4	3	2	2	2	2
		-40°C Z/Z _{20°C}	10	7	5	3	3	3
Endurance	105°C, 3,000hrs. rated voltage applied (With the rated ripple current)	ΔC/C	Within ±30% of the initial value					
		tan δ	≤ 3 times the initial specified value					
		LC	≤ The initial specified value					

Marking, Dimensions

Lot No.

80

220

16S

Rated Capacitance

Series Symbol

Rated Voltage(6.3V →6)

(Unit : mm)

D ^{+0.5max}	L ^{+0.3}	W ^{+0.2}	H ^{+0.2}	C ^{+0.2}	R	P ^{+0.2}
5	6.0	5.3	5.3	6.0	0.5 to 0.8	1.4
6.3	6.0	6.6	6.6	7.3	0.5 to 0.8	2.2
6.3	7.7	6.6	6.6	7.3	0.5 to 0.8	2.2

Size List, Impedance, Rated Ripple Current

μF \ V	6.3	10	16	25	35	50
10					5 x 6.0 1.30 95	6.3 x 6.0 2.00 70
22			5 x 6.0 1.30 95	5 x 6.0 1.30 95	6.3 x 6.0 0.70 140	6.3 x 6.0 2.00 70
33		5 x 6.0 1.30 95		6.3 x 6.0 0.70 140		6.3 x 7.7 1.35 100
47	5 x 6.0 1.30 95		6.3 x 6.0 0.70 140	6.3 x 6.0 0.70 140	6.3 x 7.7 0.60 230	
100	6.3 x 6.0 0.70 140		6.3 x 6.0 0.70 140	6.3 x 7.7 0.60 230		
150		6.3 x 6.0 0.70 140	6.3 x 7.7 0.60 230			
220	6.3 x 7.7 0.60 230		6.3 x 7.7 0.60 230			
330	6.3 x 7.7 0.60 230					

Please refer to page 16 for the ripple current frequency coefficient.

Case size ; φ D x L (mm)

Impedance (Ω) max at 100kHz, 20°C

Rated ripple current mArms (100kHz, 105°C)

Model No.

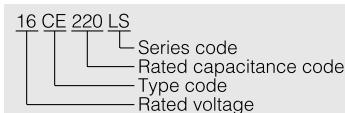

CE-LH Series

Long Life



- 105°C, 5,000hrs
- Solvent proof (within 2 minutes)

Specifications

Items	Condition	Specifications							
Rated voltage (V)	—	6.3	10	16	25	35	50		
Surge voltage (V)	Room temperature	8.0	13	20	32	44	63		
Category temperature range (°C)	—	-40 to +105							
Capacitance tolerance (%)	120Hz/20°C	M : ±20							
Dissipation Factor (DF)	120Hz/20°C	0.32	0.24	0.20	0.16	0.13	0.12		
Leakage current (LC)	μA/after 2minutes (max)	The greater value of either 0.01CV or 3							
Impedance ratio at low temperature	Based the value at 120Hz, +20°C	-25°C	Z/Z _{20°C}	4	3	2	2	2	2
		-40°C	Z/Z _{20°C}	10	7	5	3	3	3
Endurance	105°C, 5,000hrs. rated voltage applied (With the rated ripple current)	ΔC/C	Within ±30% of the initial value						
		tan δ	≤ 3 times the initial specified value						
		LC	≤ The initial specified value						

Marking, Dimensions

Polarity (Cathode)

Lot No.

80 Rated Capacitance

100 Series Symbol

ALH

Rated Voltage (6.3V : 6, 10V : A, 16V : C, 25V : E, 35V : V, 50V : H)

(Unit : mm)

D ^{+0.5max}	L ^{±0.3}	W ^{+0.2}	H ^{+0.2}	C ^{+0.2}	R	P ^{+0.2}
4	6.0	4.3	4.3	5.0	0.5 to 0.8	1.0
5	6.0	5.3	5.3	6.0	0.5 to 0.8	1.4
6.3	6.0	6.6	6.6	7.3	0.5 to 0.8	2.2
6.3	7.7	6.6	6.6	7.3	0.5 to 0.8	2.2

Size List, Rated Ripple Current

μF \ V	6.3	10	16	25	35	50
0.1						4 x 6.0 1.0
0.22						4 x 6.0 2.6
0.33						4 x 6.0 3.2
0.47						4 x 6.0 3.8
1.0						4 x 6.0 6.2
2.2						4 x 6.0 11
3.3						4 x 6.0 14
4.7					4 x 6.0 15	5 x 6.0 19
10			4 x 6.0 18	5 x 6.0 25	5 x 6.0 25	6.3 x 6.0 30
22		5 x 6.0 30	5 x 6.0 30	6.3 x 6.0 42	6.3 x 6.0 42	6.3 x 7.7 49
33	5 x 6.0 35	5 x 6.0 35	6.3 x 6.0 48	6.3 x 6.0 48	6.3 x 7.7 57	
47	5 x 6.0 36	6.3 x 6.0 50	6.3 x 6.0 50	6.3 x 7.7 63		
100	6.3 x 6.0 60	6.3 x 7.7 81	6.3 x 7.7 81			
220	6.3 x 7.7 101					

Please refer to page 16 for the ripple current frequency coefficient.

Case size ; φ D x L (mm)

Rated ripple current mArms (120Hz, 105°C)

Model No.

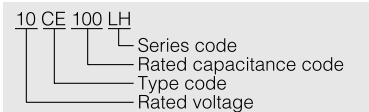

CE-LH Series

105°C Long Life

Mid and High Voltage



- 160 to 400V 105°C, 5,000hrs
- Do not clean the capacitors using solvent.

Specifications

Items	Condition	Specifications		
Rated voltage (V)	—	160	200	400
Surge voltage (V)	Room temperature	200	250	450
Category temperature range (°C)	—	-40 to +105		
Capacitance tolerance (%)	120Hz/20°C	M : ±20		
Dissipation Factor (DF)	120Hz/20°C	0.20	0.20	0.25
Leakage current (LC)	μA/after 2minutes (max)	CV ≤ 1,000	0.03CV + 15	
		CV > 1,000	0.02CV + 25	
Impedance ratio at low temperature	Based the value at 120Hz, +20°C	-25°C Z/Z _{20°C}	3	6
		-40°C Z/Z _{20°C}	6	10
Endurance	105°C, 5,000hrs. rated voltage applied (With the rated ripple current)	ΔC/C	Within ±30% of the initial value	
		tan δ	≤ 3 times the initial specified value	
		LC	≤ The initial specified value	

Marking, Dimensions

φD≤10
Polarity (Cathode)
Lot No.
80
Rated Capacitance
10
Series Symbol
2CL
Rated Voltage**

φD≥12.5
Polarity (Cathode)
Lot No.
Indicated Only φD=16
80T
Rated Capacitance
47
Series Symbol
2DL
Rated Voltage**

** (160V : 2C, 200V : 2D, 400V : 2G)

(Unit : mm)

D ^{+0.5max}	L	W ^{+0.2}	H ^{+0.2}	C ^{+0.2}	R	P ^{+0.2}
8	10.5 ^{+0.3}	8.3	8.3	9.0	0.7 to 1.0	3.2
10	10.5 ^{+0.3}	10.3	10.3	11.0	1.0 to 1.4	4.6
12.5	13.5 ^{+0.5}	12.8	12.8	13.5	1.0 to 1.4	4.6
16	16.5 ^{+0.5}	16.3	16.3	17.3	1.8 to 2.1	7.0

Size List, Rated Ripple Current

μF \ V	160	200	400
2.2			8 x 10.5 25
3.3			10 x 10.5 36
4.7			10 x 10.5 38
10	10 x 10.5 43		12.5 x 13.5 57
22	12.5 x 13.5 112	12.5 x 13.5 112	16 x 16.5 115
33	12.5 x 13.5 137	12.5 x 13.5 137	
47	16 x 16.5 180	16 x 16.5 180	
68	16 x 16.5 215	16 x 16.5 215	
82	16 x 16.5 235		

Please refer to page 16 for the ripple current frequency coefficient.

Case size ; φ D x L (mm)
16 x 16.5 ; CE-LHT series
Rated ripple current
mA Arms (120Hz, 105°C)

Model No.

LH series 200 CE 22 LH
 ———— Rated voltage
 ———— Type code
 ———— Rated capacitance code
 ———— Series code

LHT series 200 CE 47 LHT
 ———— Rated voltage
 ———— Type code
 ———— Rated capacitance code
 ———— Series code

CE-LL Series

Low Impedance

Long Life



- 105°C, 7,000 to 10,000hrs
- Solvent proof (within 2 minutes)

Specifications

Items	Condition	Specifications							
Rated voltage (V)	—	6.3	10	16	25	35	50		
Surge voltage (V)	Room temperature	8.0	13	20	32	44	63		
Category temperature range (°C)	—	-25 to +105							
Capacitance tolerance (%)	120Hz/20°C	M : ±20							
Dissipation Factor (DF)	120Hz/20°C	0.32	0.28	0.26	0.16	0.14	0.14		
Leakage current (LC)	μ A/after 2minutes (max)	The greater value of either 0.01CV or 3							
Impedance ratio at low temperature	Based the value at 120Hz, +20°C	-25°C	Z/Z _{20°C}	4	3	2	2	2	2
Endurance	105°C, rated voltage applied (With the rated ripple current)	test	φ D ≤ 6.3 : 7,000hrs., φ D ≥ 8 : 10,000hrs.						
		ΔC/C	Within ±30% of the initial value						
		tan δ	≤ 3 times the initial specified value						
		LC	≤ The initial specified value						

Marking, Dimensions

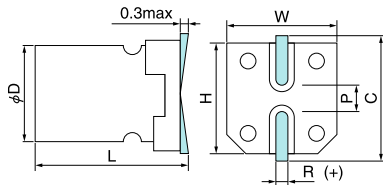
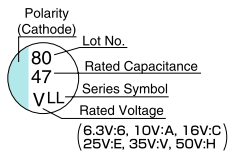

A pressure relief vent is attached to products over φ D=8

(Unit : mm)

D ^{+0.5max}	L ^{±0.3}	W ^{±0.2}	H ^{±0.2}	C ^{±0.2}	R	P ^{±0.2}
5	7.0	5.3	5.3	6.0	0.5 to 0.8	1.4
6.3	7.0	6.6	6.6	7.3	0.5 to 0.8	2.2
6.3	8.4	6.6	6.6	7.3	0.5 to 0.8	2.2
8	10.2	8.3	8.3	9.0	0.7 to 1.0	3.2
10	10.2	10.3	10.3	11.0	1.0 to 1.4	4.6

Size List, Rated Ripple Current

μF	V	6.3		10		16		25		35		50						
10										5 X 7.0	2.2	95						
22						5 X 7.0	2.2	95	5 X 7.0	2.2	95	5 X 7.0	2.2	95				
33				5 X 7.0	2.2	95			6.3 X 7.0	1.1	140	6.3 X 8.4	1.0	230				
47		5 X 7.0	2.2	95			6.3 X 7.0	1.1	140	6.3 X 7.0	1.1	140	6.3 X 8.4	1.0	230	8 X 10.2	0.53	350
100		6.3 X 7.0	1.1	140			6.3 X 7.0	1.1	140	6.3 X 8.4	1.0	230	8 X 10.2	0.22	600	10 X 10.2	0.35	670
150				6.3 X 7.0	1.1	140	6.3 X 8.4	1.0	230									
220		6.3 X 8.4	1.0	230			6.3 X 8.4	1.0	230	8 X 10.2	0.22	600	10 X 10.2	0.16	850			
330		6.3 X 8.4	1.0	230			8 X 10.2	0.22	600	10 X 10.2	0.16	850						
470		8 X 10.2	0.22	600			10 X 10.2	0.16	850									
1000		10 X 10.2	0.16	850														

Please refer to page 16 for the ripple current frequency coefficient.

Case size ; φ D x L (mm) —
 Impedance (Ω) —
 max at 100kHz, 20°C —
 Rated ripple current
 mA rms (100kHz, 105°C)

Model No.

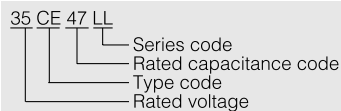

CE-PC Series

125°C Long Life



- 125°C, 1,000 to 2,000hrs
- Solvent proof (within 2 minutes)

Specifications

Items	Condition	Specifications									
Rated voltage (V)	—	6.3	10	16	25	35	50	63	100		
Surge voltage (V)	Room temperature	8.0	13	20	32	44	63	79	125		
Category temperature range (°C)	—	-55 to +125									
Capacitance tolerance (%)	120Hz/20°C	M : ±20									
Dissipation Factor (DF)	120Hz/20°C	0.30	0.24	0.20	0.16	0.14	0.14	0.12	0.10		
		When rated capacitance exceeds 1,000 μF, add 0.02 to the value above for each 1,000 μF increase.									
Leakage current (LC)	μA/after 2minutes (max)	The greater value of either 0.01CV or 3									
Impedance ratio at low temperature	Based the value at 120Hz, +20°C	-25°C Z/Z _{20°C}	4	3	2	2	2	2	2	2	
		-40°C Z/Z _{20°C}	8	6	4	3	3	3	3	3	
Endurance	125°C rated voltage applied (With the rated ripple current)	Test	6.3 to 50V 2,000hrs. (φ D=6.3 : 1,000hrs.) ,63 to 100V 1,500hrs.								
		ΔC/C	Within ±30% of the initial value								
		tan δ	≤ 3 times the initial specified value								
		LC	≤ The initial specified value								

Marking, Dimensions

[φ D≤10]
Polarity (Cathode)
Lot No.
80
Rated Capacitance
220
Series Symbol
25 C
Rated Voltage(6.3V →6)

[φ D≥12.5]
Polarity (Cathode)
Lot No.
80T
Indicated Only φ D=16
Rated Capacitance
2200
Series Symbol
10 C
Rated Voltage(6.3V →6)

A pressure relief vent is attached to products over φ D=8

(Unit : mm)

D ^{+0.5max}	L ^{=0.3}	W ^{=0.2}	H ^{=0.2}	C ^{=0.2}	R	P ^{=0.2}
6.3	6.0	6.6	6.6	7.3	0.5 to 0.8	2.2
6.3	7.7	6.6	6.6	7.3	0.5 to 0.8	2.2
8	10.2	8.3	8.3	9.0	0.7 to 1.0	3.2
10	10.2	10.3	10.3	11.0	1.0 to 1.4	4.6
12.5	13.5 ^{±0.5}	12.8	12.8	13.5	1.0 to 1.4	4.6
16	16.5 ^{±0.5}	16.3	16.3	17.3	1.8 to 2.1	7.0

Size List, ESR, Rated Ripple Current

μF \ V	6.3	10	16	25	35	50	63	100
1.0						6.3 X 6.0 3.5 45		
2.2						6.3 X 6.0 3.5 45		
3.3						6.3 X 6.0 3.5 45		
4.7					6.3 X 6.0 2.0 60	6.3 X 6.0 3.5 45		
10					6.3 X 6.0 1.6 70	6.3 X 6.0 2.8 50		8 X 10.2 1.0 70
22					6.3 X 6.0 1.6 70	6.3 X 7.7 2.0 80	8 X 10.2 1.0 100	8 X 10.2 1.0 70
33				6.3 X 6.0 1.6 70	6.3 X 7.7 0.9 110	6.3 X 7.7 2.0 80 8 X 10.2 0.7 140	8 X 10.2 1.0 100	10 X 10.2 0.80 115
47		6.3 X 6.0 1.6 70	6.3 X 6.0 1.6 70	6.3 X 7.7 0.9 110	6.3 X 7.7 0.9 110 8 X 10.2 0.4 160	8 X 10.2 0.7 140 10 X 10.2 0.5 240	8 X 10.2 1.0 100 10 X 10.2 0.50 150	12.5 X 13.5 0.33 350
100	6.3 X 6.0 1.6 70	6.3 X 7.7 0.9 110	8 X 10.2 0.4 160	6.3 X 7.7 0.9 110 8 X 10.2 0.4 160	8 X 10.2 0.4 160 10 X 10.2 0.3 220	10 X 10.2 0.5 240 12.5 X 13.5 0.23 490	10 X 10.2 0.50 150 12.5 X 13.5 0.25 350	16 X 16.5 0.24 500
220	6.3 X 7.7 0.9 110	6.3 X 7.7 0.9 110 8 X 10.2 0.4 160	8 X 10.2 0.4 160	8 X 10.2 0.4 160 10 X 10.2 0.3 220	10 X 10.2 0.3 220 12.5 X 13.5 0.12 550	12.5 X 13.5 0.23 490	12.5 X 13.5 0.25 350 16 X 16.5 0.18 500	
330	8 X 10.2 0.4 160	8 X 10.2 0.4 160	10 X 10.2 0.3 220	10 X 10.2 0.3 220 12.5 X 13.5 0.12 550	12.5 X 13.5 0.12 550	12.5 X 13.5 0.23 490 16 X 16.5 0.15 800	16 X 16.5 0.18 500	
470	8 X 10.2 0.4 160	10 X 10.2 0.3 220	12.5 X 13.5 0.12 550	12.5 X 13.5 0.12 550	12.5 X 13.5 0.12 550 16 X 16.5 0.08 900	16 X 16.5 0.15 800	16 X 16.5 0.18 500	
680	10 X 10.2 0.3 220	12.5 X 13.5 0.12 550	12.5 X 13.5 0.12 550	12.5 X 13.5 0.12 550	16 X 16.5 0.08 900	16 X 16.5 0.15 800		
1000	12.5 X 13.5 0.12 550	12.5 X 13.5 0.12 550	12.5 X 13.5 0.12 550	16 X 16.5 0.08 900	16 X 16.5 0.08 900			
1500	12.5 X 13.5 0.12 550	12.5 X 13.5 0.12 550	16 X 16.5 0.08 900	16 X 16.5 0.08 900				
2200	12.5 X 13.5 0.12 550	16 X 16.5 0.08 900	16 X 16.5 0.08 900					
3300	16 X 16.5 0.08 900	16 X 16.5 0.08 900						
4700	16 X 16.5 0.08 900							

Please refer to page 16 for the ripple current frequency coefficient.

Upper; PCS series
Lower; PC series

Case size ; ϕ D x L (mm)
16 x 16.5 ; CE-PCT series

Rated ripple current
mA rms (100kHz, 125°C)

ESR (Ω)
max at 100kHz, 20°C

Model No.

PC series 25 CE 220 PC
 Series code
 Rated capacitance code
 Type code
 Rated voltage

PCS series 25 CE 220 PCS
 Series code
 Rated capacitance code
 Type code
 Rated voltage

PCT series 10 CE 2200 PCT
 Series code
 Rated capacitance code
 Type code
 Rated voltage

CE-PH Series

125°C Low Impedance

Hi-Ripple, Hi-Capacitance, Long life



- 125°C, 2,000hrs
- Suitable for Automotive Application
- Solvent proof (within 2 minutes)

Specifications

Items	Condition	Specifications		
Rated voltage (V)	—	16	25	35
Surge voltage (V)	Room temperature	20	32	44
Category temperature range (°C)	—	-40 to +125		
Capacitance tolerance (%)	120Hz/20°C	M : ±20		
Dissipation Factor (DF)	120Hz/20°C	0.20	0.16	0.14
Leakage current (LC)	μA/after 2minutes (max)	The greater value of either 0.01CV or 3		
Impedance ratio at low temperature	Based the value at 120Hz, +20°C	-25°C Z/Z _{20°C}	2	2
		-40°C Z/Z _{20°C}	4	3
Endurance	125°C, 2,000hrs. rated voltage applied (With the rated ripple current)	ΔC/C	Within ±30% of the initial value	
		tan δ	≤ 3 times the initial specified value	
		LC	≤ The initial specified value	

Marking, Dimensions

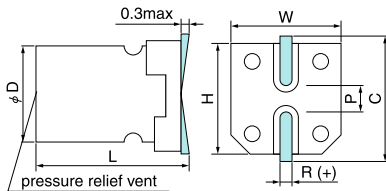
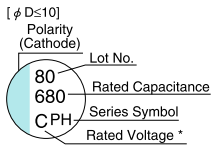

(Unit : mm)

D ^{+0.5max}	L	W ^{+0.2}	H ^{+0.2}	C ^{+0.2}	R	P ^{+0.2}
8	10.5 ^{+0.3}	8.3	8.3	9.0	0.7 to 1.0	3.2
10	10.5 ^{+0.3}	10.3	10.3	11.0	1.0 to 1.4	4.6
12.5	13.5 ^{+0.5}	12.8	12.8	13.5	1.0 to 1.4	4.6

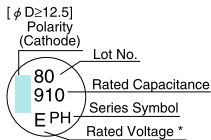

*(16V:C,25V:E,35V:V)

Size List, Impedance, Rated Ripple Current

μF \ V	16 (C)			25 (E)			35 (V)		
160							8 x 10.5	0.18	300
270				8 x 10.5	0.18	300			
300							10 x 10.5	0.11	500
390	8 x 10.5	0.18	300						
470				10 x 10.5	0.11	500			
620							12.5 x 13.5	0.08	1200
680	10 x 10.5	0.11	500						
910				12.5 x 13.5	0.08	1200			
1500	12.5 x 13.5	0.08	1200						

Please refer to page 16 for the ripple current frequency coefficient.

Case size ;
φ D x L (mm)

Impedance (Ω)
max at 100kHz, 20°C

Rated ripple current
mA_{rms} (100kHz, 125°C)

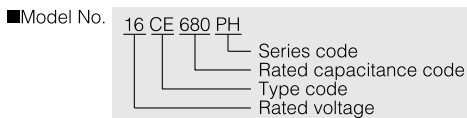

CE-NP Series

Bi-polar

5.4mm Height



- 85°C, 2,000hrs
- Solvent proof (within 2 minutes)

Specifications

Items	Condition	Specifications							
Rated voltage (V)	—	6.3	10	16	25	35	50		
Surge voltage (V)	Room temperature	8.0	13	20	32	44	63		
Category temperature range (°C)	—	-40 to +85							
Capacitance tolerance (%)	120Hz/20°C	M : ±20							
Dissipation Factor (DF)	120Hz/20°C	0.26	0.22	0.20	0.20	0.20	0.18		
Leakage current (LC)	μA/after 1minute (max)	0.03CV + 6							
Impedance ratio at low temperature	Based the value at 120Hz, +20°C	-25°C	Z/Z _{20°C}	4	3	2	2	2	2
		-40°C	Z/Z _{20°C}	8	6	4	4	3	3
Endurance	500hrs.×4(alternately) 85°C, rated voltage applied (With the rated ripple current)	ΔC/C	Within ±25% of the initial value						
		tan δ	≤ 2 times the initial specified value						
		LC	≤ The initial specified value						

Marking, Dimensions

Lot No.
80
Rated Capacitance
10
Series Symbol
16N
Rated Voltage(6.3V→6)

0.3max

(Unit : mm)

D ^{+0.5max}	L ^{+0.1 -0.2}	W ^{±0.2}	H ^{±0.2}	C ^{±0.2}	R	P ^{±0.2}
4	5.4	4.3	4.3	5.0	0.5 to 0.8	1.0
5	5.4	5.3	5.3	6.0	0.5 to 0.8	1.4
6.3	5.4	6.6	6.6	7.3	0.5 to 0.8	2.2

Size List, Rated Ripple Current

μF \ V	6.3		10		16		25		35		50	
0.10											4	1.0
0.22											4	2.3
0.33											4	3.5
0.47											4	5.0
1.0											4	10
2.2									4	8.4	5	15
3.3							4	10	5	17	5	18
4.7					4	12	5	19	5	20	6.3	23
10			4	17	5	25	6.3	28	6.3	30		
22	5	31	6.3	35	6.3	39						
33	6.3	39	6.3	43	6.3	57						
47	6.3	47										

Please refer to page 16 for the ripple current frequency coefficient.

Case size ; φ D (mm)

Rated ripple current
mA rms (120Hz, 85°C)

Model No.

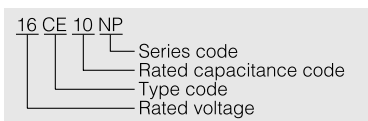

CE-FN Series

Bi-polar 105°C

5.4mm Height



- 105°C, 1,000hrs
- Solvent proof (within 2 minutes)

Specifications

Items	Condition	Specifications								
Rated voltage (V)	—	6.3	10	16	25	35	50	63		
Surge voltage (V)	Room temperature	8.0	13	20	32	44	63	79		
Category temperature range (°C)	—	-55 to +105								
Capacitance tolerance (%)	120Hz/20°C	M : ±20								
Dissipation Factor (DF)	120Hz/20°C	0.24	0.22	0.20	0.20	0.20	0.18	0.16		
Leakage current (LC)	μ A/after 1minute (max)	0.03CV + 6								
Impedance ratio at low temperature	Based the value at 120Hz, +20°C	-40°C Z/Z _{20°C}	3	3	2	2	2	2	2	
		-55°C Z/Z _{20°C}	8	6	4	4	3	3	3	
Endurance	500hrs. X2(alternately) 105°C, rated voltage applied (With the rated ripple current)	Δ C/C	Within ±25% of the initial value							
		tan δ	≤ 2 times the initial specified value							
		LC	≤ The initial specified value							

Marking, Dimensions

Lot No.

80 Rated Capacitance

10 Series Symbol

16F Rated Voltage(6.3V→6)

0.3max

(Unit : mm)

D ^{+0.5max}	L ^{+0.1 -0.2}	W ^{+0.2}	H ^{+0.2}	C ^{+0.2}	R	P ^{+0.2}
4	5.4	4.3	4.3	5.0	0.5 to 0.8	1.0
5	5.4	5.3	5.3	6.0	0.5 to 0.8	1.4
6.3	5.4	6.6	6.6	7.3	0.5 to 0.8	2.2

Size List, Rated Ripple Current

μ F	V	6.3	10	16	25	35	50	63
0.10							4	0.7
0.22							4	1.6
0.33							4	2.4
0.47							4	3.5
1.0							4	7
2.2						4	5.9	5
3.3					4	7	5	12
4.7				4	8	5	14	6.3
10			4	12	5	17	6.3	21
22	5	22	6.3	25	6.3	27		
33	6.3	27	6.3	30	6.3	40		
47	6.3	33						

Please refer to page 16 for the ripple current frequency coefficient.

Case size ; ϕ D (mm)

Rated ripple current
mA rms (120Hz, 105°C)

Model No.

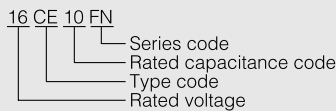

ME-UW Series

Standard

5mm Height

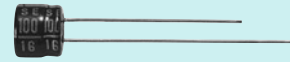

- Solvent proof (within 2 minutes)

Specifications

Items	Condition	Specifications							
Rated voltage (V)	—	4.0	6.3	10	16	25	35	50	
Surge voltage (V)	Room temperature	5.0	8.0	13	20	32	44	63	
Category temperature range (°C)	—	-40 to +85							
Capacitance tolerance (%)	120Hz/20°C	M : ±20							
Dissipation Factor (DF)	120Hz/20°C	0.35	0.24	0.20	0.16	0.14	0.12	0.10	
Leakage current (LC)	μA/after 2minutes (max)	The greater value of either 0.01CV or 3							
Impedance ratio at low temperature	Based the value at 120Hz, +20°C	-25°C	Z/Z _{20°C}	7	4	3	2	2	2
		-40°C	Z/Z _{20°C}	15	10	8	6	4	4
Endurance	85°C, 1,000hrs. rated voltage applied (With the rated ripple current)	ΔC/C	Within ±25% of the initial value						
		tan δ	≤ 2 times the initial specified value						
		LC	≤ The initial specified value						

Dimensions

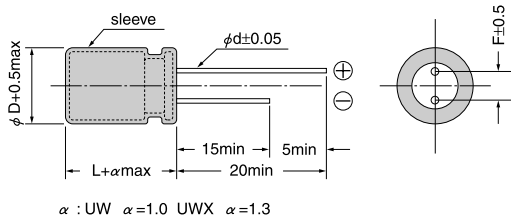

(Unit : mm)

φ D	6.3
F	2.5
φ d	0.45

Size List, Rated Ripple Current

μF	V	4.0	6.3	10	16	25	35	50
10								6.3 x 5 34
22						6.3 x 5 52	6.3 x 5 54	6.3 x 5*1 54
33					6.3 x 5 57	6.3 x 5 63	6.3 x 5*1 68	
47				6.3 x 5 59	6.3 x 5 68	6.3 x 5*1 73	6.3 x 5*1 73	
100			6.3 x 5 71	6.3 x 5 76	6.3 x 5 86			
220	6.3 x 5	82	6.3 x 5*1 90	6.3 x 5*1 90				
330	6.3 x 5*1	85	6.3 x 5*1 92					

Please refer to page 16 for the ripple current frequency coefficient.

*1 UWX Type

Case size ; φ D x L (mm)

Rated ripple current
mA rms (120Hz, 85°C)

Model No.

16 ME 33 UW

Series code
Rated capacitance code
Type code
Rated voltage

*1 10 ME 220 UWX

Series code
Rated capacitance code
Type code
Rated voltage

ME-SWB Series

Standard

7mm Height



- Solvent proof (within 3 minutes)

Specifications

Items	Condition	Specifications									
Rated voltage (V)	—	4.0	6.3	10	16	25	35	50	63		
Surge voltage (V)	Room temperature	5.0	8.0	13	20	32	44	63	79		
Category temperature range (°C)	—	-40 to +85									
Capacitance tolerance (%)	120Hz/20°C	M : ±20									
Dissipation Factor (DF)	120Hz/20°C	0.35	0.24	0.20	0.16	0.14	0.12	0.10	0.10		
Leakage current (LC)	μA/after 2minutes (max)	The greater value of either 0.01CV or 3									
Impedance ratio at low temperature	Based the value at 120Hz, +20°C	-25°C	Z/Z _{20°C}	7	4	3	2	2	2	2	2
		-40°C	Z/Z _{20°C}	15	10	7	6	4	4	4	4
Endurance	85°C, 2,000hrs. rated voltage applied (With the rated ripple current)	ΔC/C	Within ±25% of the initial value								
		tan δ	≤ 2 times the initial specified value								
		LC	≤ The initial specified value								

Dimensions

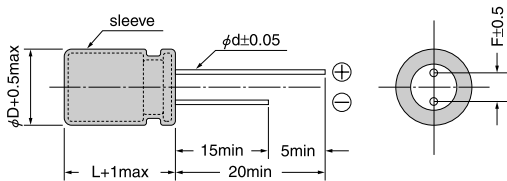

(Unit : mm)

φD	4	5	6.3
F	1.5	2.0	2.5
φd	0.45	0.45	0.45

Size List, Rated Ripple Current

V	4.0		6.3		10		16		25		35		50		63	
μF																
0.10													4 x 7	1.0	4 x 7	1.2
0.22													4 x 7	2.3	4 x 7	2.9
0.33													4 x 7	3.5	4 x 7	4.4
0.47													4 x 7	5.0	4 x 7	5.0
1.0													4 x 7	10	4 x 7	10
2.2													4 x 7	15	4 x 7	17
3.3									4 x 7	16	4 x 7	17	4 x 7	18	4 x 7	21
4.7									4 x 7	19	4 x 7	20	4 x 7	23	5 x 7	26
10							4 x 7	25	4 x 7	28	5 x 7	30	5 x 7	34	6.3 x 7	43
22			4 x 7	31	4 x 7	35	4 x 7	39	5 x 7	52	6.3 x 7	54	6.3 x 7	60	6.3 x 7	65
33	4 x 7	26	4 x 7	39	4 x 7	43	5 x 7	57	6.3 x 7	63	6.3 x 7	65	6.3 x 7	70		
47	4 x 7	34	4 x 7	47	5 x 7	59	5 x 7	68	6.3 x 7	70	6.3 x 7	75	6.3 x 7	80		
100	5 x 7	61	5 x 7	71	6.3 x 7	80	6.3 x 7	91	6.3 x 7	100	6.3 x 7	105				
150							6.3 x 7	105								
220	6.3 x 7	82	6.3 x 7	103	6.3 x 7	110	6.3 x 7	110								
330	6.3 x 7	100	6.3 x 7	110												
470	6.3 x 7	110														

Please refer to page 16 for the ripple current frequency coefficient.

Case size : φD x L (mm)

Rated ripple current
mA rms (120Hz, 85°C)

Model No.

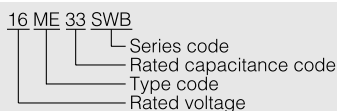

ME-HC Series

Standard



- Solvent proof (within 5 minutes)

Specifications

Items	Condition	Specifications								
Rated voltage (V)	—	6.3	10	16	25	35	50	63	100	
Surge voltage (V)	Room temperature	8.0	13	20	32	44	63	79	125	
Category temperature range (°C)	—	-40 to +85								
Capacitance tolerance (%)	120Hz/20°C	M : ±20								
Dissipation Factor (DF)	120Hz/20°C	0.28	0.24	0.20	0.16	0.14	0.12	0.10	0.10	
		When rated capacitance exceeds 1,000 µF, add 0.02 to the value above for each 1,000 µF increase.								
Leakage current (LC)	µA/after 2minutes (max)	The greater value of either 0.01CV or 3								
Impedance ratio at low temperature	Based the value at 120Hz, +20°C	-25°C Z/Z _{20°C}	5	4	3	2	2	2	2	2
		-40°C Z/Z _{20°C}	12	10	8	6	4	4	4	4
Endurance	85°C, 2,000hrs. rated voltage applied (With the rated ripple current)	ΔC/C	Within ±25% of the initial value							
		tan δ	≤ 2 times the initial specified value							
		LC	≤ The initial specified value							

Dimensions

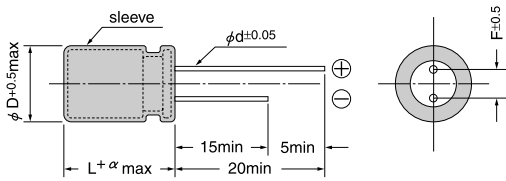

$\alpha : L < 20 \alpha = 1.5, L \geq 20 \alpha = 2.0$

A pressure relief vent is attached to products over $\phi D = 6.3$

(Unit : mm)

ϕD	5	6.3	8	10	12.5	16	18
F	2.0	2.5	3.5	5.0	5.0	7.5	7.5
ϕd	0.5	0.5	0.6	0.6	0.6	0.8	0.8

Size List, Rated Ripple Current

V	6.3		10		16		25		35		50		63		100	
0.10											5 x 11	1.0	5 x 11	1.2	5 x 11	2.1
0.22											5 x 11	2.5	5 x 11	3.0	5 x 11	4.7
0.33											5 x 11	4.0	5 x 11	4.8	5 x 11	7.0
0.47											5 x 11	5.0	5 x 11	5.0	5 x 11	10
1.0											5 x 11	10	5 x 11	10	5 x 11	21
2.2											5 x 11	20	5 x 11	20	5 x 11	30
3.3											5 x 11	28	5 x 11	28	5 x 11	40
4.7											5 x 11	38	5 x 11	40	5 x 11	50
10					5 x 11	28	5 x 11	40	5 x 11	45	5 x 11	50	5 x 11	60	6.3 x 11	70
22			5 x 11	38	5 x 11	50	5 x 11	60	5 x 11	75	5 x 11	90	5 x 11	105	8 x 11.5	120
33	5 x 11	50	5 x 11	58	5 x 11	60	5 x 11	80	5 x 11	90	5 x 11	110	6.3 x 11	130	8 x 12.5	145
47	5 x 11	60	5 x 11	70	5 x 11	85	5 x 11	90	5 x 11	125	6.3 x 11	135	6.3 x 11	160	10 x 12.5	180
100	5 x 11	120	5 x 11	125	5 x 11	165	6.3 x 11	180	6.3 x 11	200	8 x 11.5	250	8 x 12.5	280	10 x 20	350
220	5 x 11	210	5 x 11	210	6.3 x 11	260	8 x 11.5	320	8 x 11.5	320	10 x 12.5	410	10 x 16	450	12.5 x 25	550
330	6.3 x 11	260	6.3 x 11	295	8 x 11.5	360	8 x 11.5	380	10 x 12.5	440	10 x 16	580	10 x 20	600	16 x 25	750
470	6.3 x 11	330	6.3 x 11	330	8 x 11.5	380	10 x 12.5	540	10 x 16	585	10 x 20	750	12.5 x 20	800	16 x 31.5	950
1000	8 x 11.5	420	10 x 12.5	620	10 x 16	740	10 x 20	940	12.5 x 20	1000	12.5 x 25	1150	16 x 25	1250		
2200	10 x 16	890	10 x 20	1000	12.5 x 20	1150	12.5 x 25	1350	16 x 25	1500	16 x 31.5	1700				
3300	10 x 20	1080	12.5 x 20	1300	12.5 x 25	1500	16 x 25	1600	16 x 35.5	1750	18 x 35.5	1850				
4700	12.5 x 20	1400	12.5 x 25	1550	16 x 25	1750	16 x 31.5	1900	18 x 35.5	2000						
6800	12.5 x 25	1600	16 x 25	1800	16 x 31.5	1900	18 x 35.5	2000								
10000	16 x 25	1750	16 x 31.5	1900	18 x 35.5	2000										
15000	16 x 35.5	1900	18 x 35.5	2000												

Please refer to page 16 for the ripple current frequency coefficient.

Case size ; $\phi D \times L$ (mm)

Rated ripple current
mA rms (120Hz, 85°C)

Model No.

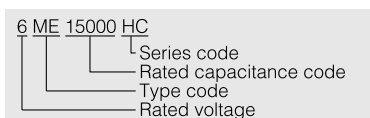

ME-HPC-HPD Series

Miniature, Mid. and High Voltage

Low Profile, Mid. and High Voltage



• Do not clean the capacitors using solvent

Specifications

Items	Condition	Specifications						
Rated voltage (V)	—	160	200	250	350	400	450	
Surge voltage (V)	Room temperature	200	250	300	400	450	500	
Category temperature range (°C)	—	-40 to +85			-25 to +85			
Capacitance tolerance (%)	120Hz/20°C	M : ±20						
Dissipation Factor (DF)	120Hz/20°C	0.20	0.20	0.20	0.25	0.25	0.25	
Leakage current (LC)	μA /after 2minutes (max)	CV ≤ 1,000	0.03CV + 15					
		CV > 1,000	0.02CV + 25					
Impedance ratio at low temperature	Based the value at 120Hz, +20°C	-25°C Z/Z _{20°C}	3	3	3	4	6	12
		-40°C Z/Z _{20°C}	6	6	6	—	—	—
Endurance	85°C, 2,000hrs. rated voltage applied (With the rated ripple current)	$\Delta C/C$	Within ±20% of the initial value					
		tan δ	≤ 2 times the initial specified value					
		LC	≤ The initial specified value					

Dimensions

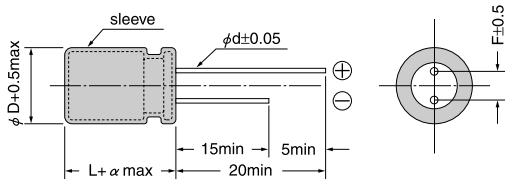

α : L < 20 α = 1.5, L ≥ 20 α = 2.0

A pressure relief vent is attached to products over $\phi D=6.3$

(Unit : mm)

ϕD	5	6.3	8	10	12.5	16	18
F	2.0	2.5	3.5	5.0	5.0	7.5	7.5
ϕd	0.5	0.5	0.6	0.6	0.6	0.8	0.8

Size List, Rated Ripple Current

μF \ V	160	200	250	350	400	450
0.47	5 x 11	5 x 11	5 x 11	6.3 x 11	6.3 x 11	6.3 x 11
1.0	5 x 11	5 x 11	5 x 11	6.3 x 11	6.3 x 11	6.3 x 11
2.2	6.3 x 11	6.3 x 11	6.3 x 11	8 x 11.5	8 x 11.5	8 x 11.5
3.3	6.3 x 11	6.3 x 11	6.3 x 11	8 x 11.5	8 x 11.5	8 x 11.5
4.7	6.3 x 11	8 x 11.5	8 x 11.5	10 x 12.5	10 x 12.5	10 x 12.5
10	8 x 11.5	8 x 12.5	10 x 12.5	10 x 16	10 x 20	12.5 x 25
22	10 x 12.5	10 x 16	10 x 20	12.5 x 20	12.5 x 25	16 x 21
33	10 x 20	10 x 20	12.5 x 20	12.5 x 25	16 x 21	16 x 25
47	12.5 x 20	12.5 x 20	12.5 x 25	16 x 21	16 x 25	18 x 21
68	12.5 x 20	12.5 x 25	16 x 21	16 x 25	16 x 30.5	18 x 25
82	12.5 x 25	16 x 21	16 x 30	18 x 25	18 x 30.5	18 x 35.5
100	12.5 x 25	16 x 21	16 x 30	18 x 25	18 x 35.5	18 x 35.5
150	16 x 30	16 x 35.5	18 x 35.5	18 x 35.5	18 x 35.5	18 x 35.5
220	16 x 35.5	18 x 30.5	18 x 35.5	18 x 35.5	18 x 35.5	18 x 35.5

Please refer to page 16 for the ripple current frequency coefficient.

Upper ; HPC series (0.47 μF to 4.7 μF ; HPC series)
Lower ; HPD series

Case size ; $\phi D \times L$ (mm)

Rated ripple current
mA Arms (120Hz, 85°C)

Model No.

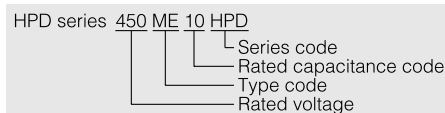
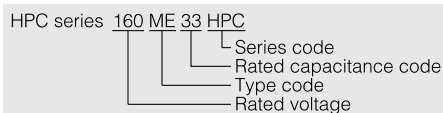

ME-UZ-SZ Series

5mm Height, Wide Temperature Range

7mm Height, Wide Temperature Range



- ME-UZ: 105°C, 1,000hrs, Solvent proof (within 2 minutes)
- ME-SZ: 105°C, 1,000hrs, Solvent proof (within 3 minutes)

Specifications

Items	Condition	Specifications						
Rated voltage (V)	—	6.3	10	16	25	35	50	
Surge voltage (V)	Room temperature	8.0	13	20	32	44	63	
Category temperature range (°C)	—	-55 to +105						
Capacitance tolerance (%)	120Hz/20°C	M : ±20						
Dissipation Factor (DF)	120Hz/20°C	0.24	0.20	0.16	0.14	0.12	0.10	
Leakage current (LC)	µA/after 2minutes (max)	The greater value of either 0.01CV or 3						
Impedance ratio at low temperature	Based the value at 120Hz, +20°C	-40°C Z/Z _{20°C}	3	2	2	2	2	2
		-55°C Z/Z _{20°C}	5	4	4	3	3	3
Endurance	105°C, 1,000hrs. rated voltage applied (With the rated ripple current)	ΔC/C	Within ±25% of the initial value					
		tan δ	≤ 2 times the initial specified value					
		LC	≤ The initial specified value					

Dimensions

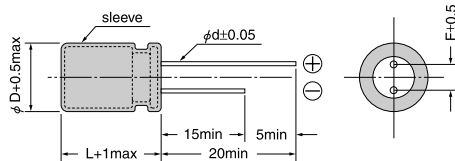

(Unit : mm)

φ D	4	5	6.3
F	1.5	2.0	2.5
φ d	0.45	0.45	0.45

Size List, Impedance, Rated Ripple Current

UZ Series

µF \ V	6.3		10		16		25		35		50	
10												
22							6.3 x 5	1.6	100	6.3 x 5	2.0	70
33							6.3 x 5	1.6	100	6.3 x 5	2.0	70
47				6.3 x 5	1.6	100	6.3 x 5	1.6	100	6.3 x 5	2.0	70
100	6.3 x 5	1.6	100	6.3 x 5	1.6	100	6.3 x 5	1.6	100			
220	6.3 x 5	1.6	100									

SZ Series

µF \ V	6.3		10		16		25		35		50							
0.10											4 x 7	30	10					
0.22											4 x 7	16	10					
0.33											4 x 7	13	15					
0.47											4 x 7	12	20					
1.0											4 x 7	10	30					
2.2											4 x 7	7.8	35					
3.3											4 x 7	6.2	40					
4.7											4 x 7	6.2	40					
10							4 x 7	4.2	50	4 x 7	6.0	40	5 x 7	3.1	70			
22	4 x 7	4.2	50	5 x 7	2.0	85	5 x 7	2.0	85	5 x 7	3.1	70	6.3 x 7	1.6	100	6.3 x 7	1.6	100
33	5 x 7	2.0	85	5 x 7	2.0	85	6.3 x 7	1.2	120	6.3 x 7	1.6	100	6.3 x 7	1.6	100	6.3 x 7	1.6	100
47	5 x 7	2.0	85	6.3 x 7	1.2	120	6.3 x 7	1.2	120	6.3 x 7	1.6	100	6.3 x 7	1.6	100	6.3 x 7	1.6	100
100	6.3 x 7	1.2	120	6.3 x 7	1.2	120	6.3 x 7	1.2	120	6.3 x 7	1.6	100						
220	6.3 x 7	1.2	120	6.3 x 7	1.2	120	6.3 x 7	1.2	120									
330	6.3 x 7	1.2	120															

Please refer to page 16 for the ripple current frequency coefficient.

Case size ;
φ D x L (mm)

Rated ripple current
mA rms (100kHz, 105°C)

Impedance (Ω)
max at 100kHz, 20°C

Model No.

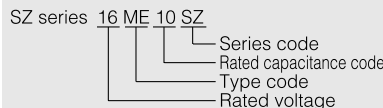
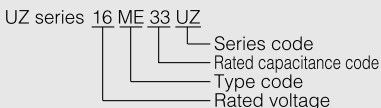

ME-CZ Series

Temperature of Wide Range

Smaller in Size Miniature Standard



- 105°C, 1,000 to 3,000hrs
- Solvent proof (within 5 minutes)

Specifications

Items	Condition	Specifications									
Rated voltage (V)	—	6.3	10	16	25	35	50	63	100		
Surge voltage (V)	Room temperature	8.0	13	20	32	44	63	79	125		
Category temperature range (°C)	—	-55 to +105									
Capacitance tolerance (%)	120Hz/20°C	M : ±20									
Dissipation Factor (DF)	120Hz/20°C	0.28	0.24	0.20	0.16	0.14	0.12	0.10	0.10		
		When rated capacitance exceeds 1,000 µF, add 0.02 to the value above for each 1,000 µF increase.									
Leakage current (LC)	µA/after 2minutes (max)	The greater value of either 0.01CV or 3									
Impedance ratio at low temperature	Based the value at 120Hz, +20°C	-40°C	Z20°C	4	4	3	3	2	2	2	2
		-55°C	Z20°C	10	8	6	5	4	3	3	3
Endurance	105°C rated voltage applied (With the rated ripple current)	Test	φ 5 to φ 8 : 1,000hrs., φ 10 : 2,000hrs., φ 12.5 to φ 18 : 3,000hrs.								
		△C/C	Within ±25% of the initial value								
		tan δ	≤ 2 times the initial specified value								
		LC	≤ The initial specified value								

Dimensions

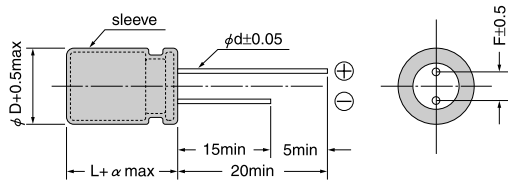

$$\alpha: L < 20 \alpha = 1.5, L \geq 20 \alpha = 2.0$$

A pressure relief vent is attached to products over φ D=6.3

(Unit : mm)

φ D	5	6.3	8	10	12.5	16	18
F	2.0	2.5	3.5	5.0	5.0	7.5	7.5
φ d	0.5	0.5	0.6	0.6	0.6	0.8	0.8

Size List, Impedance, Rated Ripple Current

V Items Case size φ D x L (mm)	6.3			10		
	Capacitance (µF)	Impedance (Ωmax) (20°C/100kHz)	Ripple current (mA rms) (105°C/100kHz)	Capacitance (µF)	Impedance (Ωmax) (20°C/100kHz)	Ripple current (mA rms) (105°C/100kHz)
5 x 11	220	1.4	160	100	1.4	150
6.3 x 11	330	0.58	240	220	0.58	240
6.3 x 11	470	0.55	250	330	0.55	250
8 x 11.5	1000	0.26	450	470	0.39	370
10 x 12.5				1000	0.16	560
10 x 16	2200	0.12	760			
10 x 20	3300	0.10	900	2200	0.10	900
12.5 x 20	4700	0.072	1100	3300	0.074	1100
12.5 x 25	6800	0.054	1420	4700	0.054	1420
16 x 25	10000	0.043	1700	6800	0.043	1700
16 x 31.5				10000	0.035	1950
16 x 35.5	15000	0.032	2100			
18 x 35.5				15000	0.028	2400

Size List, Impedance, Rated Ripple Current

V Items Case size φ D x L (mm)	16			25		
	Capacitance (μF)	Impedance (Ωmax) (20°C/100kHz)	Ripple current (mArms) (105°C/100kHz)	Capacitance (μF)	Impedance (Ωmax) (20°C/100kHz)	Ripple current (mArms) (105°C/100kHz)
5 x 11	100	1.4	150	47	1.4	150
6.3 x 11	220	0.55	240	100	0.60	240
8 x 11.5	330	0.35	370	220	0.39	370
8 x 11.5	470	0.28	450	330	0.34	400
10 x 12.5				470	0.17	560
10 x 16	1000	0.13	760			
10 x 20				1000	0.10	900
12.5 x 20	2200	0.075	1100			
12.5 x 25	3300	0.054	1320	2200	0.062	1320
16 x 25	4700	0.043	1600	3300	0.043	1600
16 x 31.5	6800	0.035	1900	4700	0.035	1900
18 x 35.5	10000	0.028	2300	6800	0.028	2200

V Items Case size φ D x L (mm)	35			50		
	Capacitance (μF)	Impedance (Ωmax) (20°C/100kHz)	Ripple current (mArms) (105°C/100kHz)	Capacitance (μF)	Impedance (Ωmax) (20°C/100kHz)	Ripple current (mArms) (105°C/100kHz)
5 x 11				0.10	30	10
5 x 11				0.22	20	10
5 x 11				0.33	15	10
5 x 11				0.47	10	20
5 x 11				1.0	7.0	30
5 x 11				2.2	5.5	40
5 x 11				3.3	4.0	50
5 x 11				4.7	2.8	80
5 x 11				10	2.3	90
5 x 11	33	2.1	120	22	2.2	110
5 x 11	47	2.1	140	33	2.1	120
6.3 x 11	100	1.1	180	47	1.1	180
8 x 11.5	220	0.46	360	100	0.55	310
10 x 12.5	330	0.26	500	220	0.30	500
10 x 16	470	0.18	650	330	0.20	650
10 x 20				470	0.13	800
12.5 x 20	1000	0.11	900			
12.5 x 25				1000	0.10	1100
16 x 25	2200	0.056	1400			
16 x 31.5				2200	0.055	1650
16 x 35.5	3300	0.038	1800			
18 x 35.5	4700	0.035	2000	3300	0.035	2000

V Items Case size φ D x L (mm)	63			100		
	Capacitance (μF)	Impedance (Ωmax) (20°C/100kHz)	Ripple current (mArms) (105°C/100kHz)	Capacitance (μF)	Impedance (Ωmax) (20°C/100kHz)	Ripple current (mArms) (105°C/100kHz)
5 x 11	0.47	15	15	0.47	20	15
5 x 11	1.0	10.5	30	1.0	14	30
5 x 11	2.2	8.3	42	2.2	11	42
5 x 11	3.3	6.0	58	3.3	8.0	58
5 x 11	4.7	4.2	64	4.7	5.6	64
5 x 11	10	2.8	90			
5 x 11	22	2.4	140			
6.3 x 11	33	1.4	200	10	1.7	108
6.3 x 11	47	1.3	240			
8 x 11.5				22	0.83	235
8 x 12.5	100	0.60	300	33	0.60	300
10 x 12.5				47	0.39	330
10 x 16	220	0.22	520			
10 x 20	330	0.17	765	100	0.24	450
12.5 x 20	470	0.14	960			
12.5 x 25				220	0.15	700
16 x 25	1000	0.065	1100	330	0.090	950
16 x 31.5				470	0.085	1100

Please refer to page 16 for the ripple current frequency coefficient.

Model No.

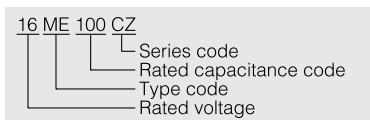

ME-UAX·SAX Series

Low Impedance

5mm Height (UAX), 7mm Height (SAX)

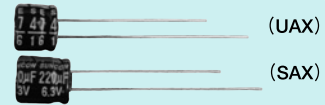

- ME-UAX: 105°C, 1,000hrs, Solvent proof (within 2 minutes)
- ME-SAX: 105°C, 1,000hrs, Solvent proof (within 3 minutes)

Specifications

Items	Condition	Specifications					
Rated voltage (V)	—	6.3	10	16	25	35	
Surge voltage (V)	Room temperature	8.0	13	20	32	44	
Category temperature range (°C)	—	-55 to +105					
Capacitance tolerance (%)	120Hz/20°C	M : ±20					
Dissipation Factor (DF)	120Hz/20°C	0.24	0.20	0.16	0.14	0.12	
Leakage current (LC)	μA/after 2minutes (max)	The greater value of either 0.01CV or 3					
Impedance ratio at low temperature	Based the value at 120Hz, +20°C	-40°C Z/Z _{20°C}	3	2	2	2	2
		-55°C Z/Z _{20°C}	5	4	4	3	3
Endurance	105°C, 1,000hrs. rated voltage applied (With the rated ripple current)	ΔC/C	Within ±25% of the initial value				
		tan δ	≤ 2 times the initial specified value				
		LC	≤ The initial specified value				

Dimensions

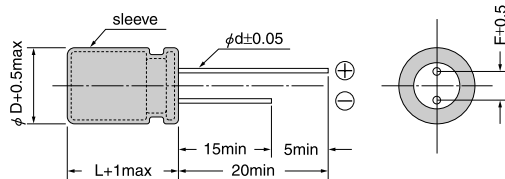

(Unit : mm)

φ D	4	5	6.3
F	1.5	2.0	2.5
φ d	0.45	0.45	0.45

Size List, Impedance, Rated Ripple Current

UAX Series

μF	6.3			10			16			25			35		
33									6.3 x 5	0.44	230	6.3 x 5	0.44	230	
47									6.3 x 5	0.44	230	6.3 x 5	0.44	230	
56									6.3 x 5	0.44	230	6.3 x 5	0.44	230	
68				6.3 x 5	0.44	230	6.3 x 5	0.44	230						
100	6.3 x 5	0.44	230				6.3 x 5	0.44	230						
120							6.3 x 5	0.44	230						
130				6.3 x 5	0.44	230	6.3 x 5	0.44	230						
150	6.3 x 5	0.44	230												
220	6.3 x 5	0.44	230												

SAX Series

μF	6.3			10			16			25			35		
4.7															
10									4 x 7	1.15	90	4 x 7	1.15	90	
15									5 x 7	0.49	160	5 x 7	0.49	160	
22				4 x 7	1.15	90	5 x 7	0.49	160	5 x 7	0.49	160	6.3 x 7	0.29	280
33				5 x 7	0.49	160				6.3 x 7	0.24	280	6.3 x 7	0.29	280
47	5 x 7	0.49	160	5 x 7	0.49	160	6.3 x 7	0.24	280	6.3 x 7	0.24	280	6.3 x 7	0.29	280
68										6.3 x 7	0.24	280			
100				6.3 x 7	0.24	280	6.3 x 7	0.24	280	6.3 x 7	0.29	280			
150				6.3 x 7	0.24	280	6.3 x 7	0.29	280						
220	6.3 x 7	0.24	280	6.3 x 7	0.29	280	6.3 x 7	0.29	280						
330	6.3 x 7	0.29	280												

Please refer to page 16 for the ripple current frequency coefficient.

Model No.

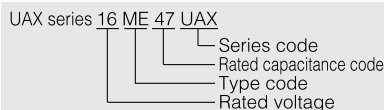

Case size ; φ D x L (mm)

Rated ripple current mArms (100kHz, 105°C)

Impedance (Ω) max at 100kHz, 20°C

ME-LS Series

105°C Long Life



- 105°C, 3,000hrs
- Solvent proof (ϕ 4 to 6.3 ; within 3minutes, ϕ 8 ; within 5 minutes)

Specifications

Items	Condition	Specifications						
Rated voltage (V)	—	6.3	10	16	25	35	50	
Surge voltage (V)	Room temperature	8.0	13	20	32	44	63	
Category temperature range (°C)	—	-40 to +105						
Capacitance tolerance (%)	120Hz/20°C	M : ±20						
Dissipation Factor (DF)	120Hz/20°C	0.30	0.28	0.24	0.18	0.16	0.14	
Leakage current (LC)	μ A/after 2minutes (max)	The greater value of either 0.01CV or 3						
Impedance ratio at low temperature	Based the value at 120Hz, +20°C	-25°C $Z/Z_{20°C}$	5	4	3	2	2	2
		-40°C $Z/Z_{20°C}$	10	8	6	4	3	3
Endurance	105°C, 3,000hrs. rated voltage applied (With the rated ripple current)	$\Delta C/C$	Within ±30% of the initial value					
		$\tan \delta$	≤ 3 times the initial specified value					
		LC	≤ The initial specified value					

Dimensions

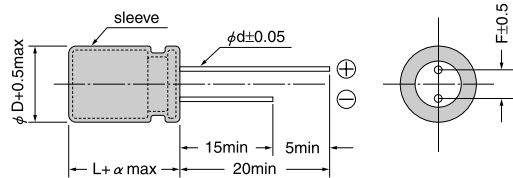

(Unit : mm)

ϕ D	4	5	6.3	8
F	1.5	2.0	2.5	3.5
ϕ d	0.45	0.45	0.45	0.60

α : L<9 $\alpha=1.0$, L≥9 $\alpha=1.5$

A pressure relief vent is attached to products ϕ 8 x 11.5

Size List, Impedance, Rated Ripple Current

μ F	V	6.3	10	16	25	35	50
1.0							4x7 17.0 23
2.2							4x7 13.0 26
3.3							4x7 11.0 29
4.7						4x7 6.6 37	5x7 9.0 37
10				4x7 4.2 46		5x7 2.3 74	6.3x7 2.5 84
22	4x7	4.2 46		5x7 2.3 74	5x7 2.3 74	6.3x7 1.2 120	6.3x7.5 1.6 112
33			5x7 2.3 74		6.3x7 1.2 120	6.3x7.5 0.75 163	
47	5x7	2.3 74		6.3x7 1.2 120	6.3x7.5 0.75 163	6.3x7.5 0.75 163	8x9 1.1 162
100	6.3x7	1.2 120		6.3x7.5 0.75 163	8x9 0.55 230		8x9 1.1 162
150			6.3x7.5 0.75 163	8x9 0.55 230			
220	6.3x7.5	0.75 163	8x9 0.55 230	8x9 0.55 230	8x11.5 0.40 298	8x11.5 0.40 298	
330	8x9	0.55 230		8x9 0.55 230	8x11.5 0.40 298		
470	8x9	0.55 230		8x11.5 0.40 298			
1000	8x11.5	0.40 298					

Please refer to page 16 for the ripple current frequency coefficient.

Case size : ϕ D x L (mm)

Rated ripple current
mA rms (100kHz, 105°C)

Impedance (Ω)
max at 100kHz, 20°C

Model No.

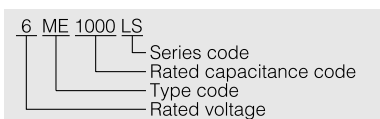

ME-CA Series

Low Impedance

Miniature



- 105°C, 1,000 to 3,000hrs
- Solvent proof (within 5 minutes)

Specifications

Items	Condition	Specifications						
Rated voltage (V)	—	6.3	10	16	25	35	50	
Surge voltage (V)	Room temperature	8.0	13	20	32	44	63	
Category temperature range (°C)	—	-55 to +105						
Capacitance tolerance (%)	120Hz/20°C	M : ±20						
Dissipation Factor (DF)	120Hz/20°C	0.28	0.24	0.20	0.16	0.14	0.12	
		When rated capacitance exceeds 1,000 μF, add 0.02 to the value above for each 1,000 μF increase.						
Leakage current (LC)	μA/after 2minutes (max)	The greater value of either 0.01CV or 3						
Impedance ratio at low temperature	Based the value at 120Hz, +20°C	-40°C Z/Z _{20°C}	3	3	2	2	2	2
		-55°C Z/Z _{20°C}	6	5	4	4	3	3
Endurance	105°C rated voltage applied (With the rated ripple current)	Test	φ 5 to φ 8 : 1,000hrs., φ 10 : 2,000hrs., φ 12.5 to φ 16 : 3,000hrs.					
		ΔC/C	Within ±25% of the initial value					
		tan δ	≤ 2 times the initial specified value					
		LC	≤ The initial specified value					

Dimensions

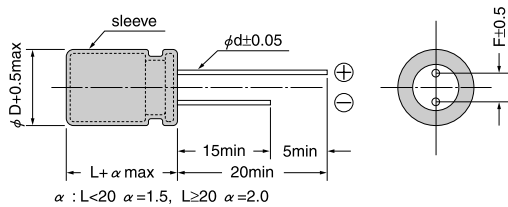

(Unit : mm)

φ D	5	6.3	8	10	12.5	16
F	2.0	2.5	3.5	5.0	5.0	7.5
φ d	0.5	0.5	0.6	0.6	0.6	0.8

A pressure relief vent is attached to products over φ D=6.3

Size List, Impedance, Rated Ripple Current

Case size φ D x L (mm)	Items	6.3			10		
		Capacitance (μF)	Impedance (Ω max) (20°C/100kHz)	Ripple current (mA rms) (105°C/10k to 200kHz)	Capacitance (μF)	Impedance (Ω max) (20°C/100kHz)	Ripple current (mA rms) (105°C/10k to 200kHz)
5 x 11		220	0.50	180			
6.3 x 11		330	0.30	280	220	0.30	280
6.3 x 11		470	0.24	280	330	0.24	280
8 x 11.5		1000	0.15	560	470	0.16	410
10 x 12.5					1000	0.086	710
10 x 16		2200	0.066	950			
10 x 20		3300	0.047	1150	2200	0.047	1150
12.5 x 20		4700	0.042	1460	3300	0.042	1460
12.5 x 25		6800	0.031	1780	4700	0.031	1780
16 x 25		10000	0.026	2000	6800	0.026	2000
16 x 31.5					10000	0.022	2200
16 x 35.5		15000	0.022	2200			

■ Size List, Impedance, Rated Ripple Current

V Case size φ D x L (mm)	Items	16			25		
		Capacitance (μF)	Impedance (Ωmax) (20°C/100kHz)	Ripple current (mArms) (105°C/10k to 200kHz)	Capacitance (μF)	Impedance (Ωmax) (20°C/100kHz)	Ripple current (mArms) (105°C/10k to 200kHz)
5 x 11		100	0.50	180			
6.3 x 11		220	0.24	280	100	0.30	280
8 x 11.5		330	0.16	410	220	0.16	410
8 x 11.5		470	0.15	560	330	0.15	560
10 x 12.5					470	0.086	710
10 x 16		1000	0.066	950			
10 x 20					1000	0.047	1150
12.5 x 20		2200	0.042	1460			
12.5 x 25		3300	0.035	1780	2200	0.035	1780
16 x 25		4700	0.026	2000	3300	0.026	2000
16 x 31.5		6800	0.022	2200	4700	0.022	2200

V Case size φ D x L (mm)	Items	35			50		
		Capacitance (μF)	Impedance (Ωmax) (20°C/100kHz)	Ripple current (mArms) (105°C/10k to 200kHz)	Capacitance (μF)	Impedance (Ωmax) (20°C/100kHz)	Ripple current (mArms) (105°C/10k to 200kHz)
5 x 11					0.47	5.5	20
5 x 11					1.0	3.3	30
5 x 11					2.2	3.0	45
5 x 11					3.3	2.7	55
5 x 11					4.7	2.0	90
5 x 11					10	1.7	110
5 x 11		33	0.72	180	22	1.2	120
5 x 11		47	0.50	180	33	0.95	130
6.3 x 11		100	0.24	280	47	0.56	190
8 x 11.5		220	0.15	560	100	0.30	320
10 x 12.5		330	0.086	710	220	0.16	520
10 x 16		470	0.066	950	330	0.12	670
10 x 20					470	0.088	820
12.5 x 20		1000	0.042	1460			
12.5 x 25					1000	0.053	1200
16 x 25		2200	0.026	2000			
16 x 31.5					2200	0.029	1750
16 x 35.5		3300	0.022	2200			

Please refer to page 16 for the ripple current frequency coefficient.

■ Model No.

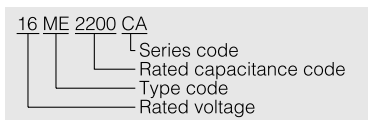

ME-CX Series

Low Impedance

Miniature, Long Life



- 105°C, 2,000 to 7,000hrs
- Solvent proof (within 5 minutes)

Specifications

Items	Condition	Specifications					
Rated voltage (V)	—	6.3	10	16	25	35	
Surge voltage (V)	Room temperature	8.0	13	20	32	44	
Category temperature range (°C)	—	-55 to +105					
Capacitance tolerance (%)	120Hz/20°C	M : ±20					
Dissipation Factor (DF)	120Hz/20°C	0.22	0.19	0.16	0.14	0.12	
		When rated capacitance exceeds 1.000 μF, add 0.02 to the value above for each 1,000 μF increase.					
Leakage current (LC)	μA/after 2minutes (max)	0.01CV					
Impedance ratio at low temperature	Based the value at 120Hz, +20°C	-40°C Z/Z _{20°C}	3	2	2	2	2
		-55°C Z/Z _{20°C}	4	4	3	3	3
Endurance	105°C rated voltage applied (With the rated ripple current)	Test	φ 5 to φ 6.3 : 2,000hrs., φ 8 : 3,000hrs., φ 10 : 4,000hrs., φ 12.5 : 5,000hrs., φ 16 to φ 18 : 7,000hrs.				
		ΔC/C	Within ±25% of the initial value				
		tan δ	≤ 2 times the initial specified value				
		LC	≤ The initial specified value				

Dimensions

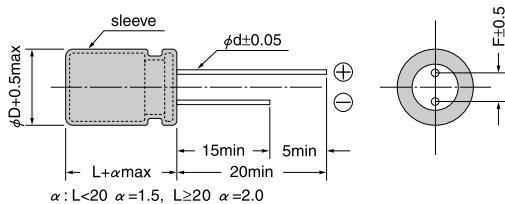

(Unit : mm)

φ D	5	6.3	8	10	12.5	16	18
F	2.0	2.5	3.5	5.0	5.0	7.5	7.5
φ d	0.5	0.5	0.6	0.6	0.6*	0.8	0.8

* φ 12.5 x 30 : φ d=0.8

A pressure relief vent is attached to products over φ D=6.3

Size List, Impedance, Rated Ripple Current

V Items Case size φ D x L (mm)	6.3			10		
	Capacitance (μF)	Impedance (Ωmax) (20°C/100kHz)	Ripple current (mArms) (105°C/10k to 200kHz)	Capacitance (μF)	Impedance (Ωmax) (20°C/100kHz)	Ripple current (mArms) (105°C/10k to 200kHz)
5 x 11	180	0.34	205	150	0.34	205
6.3 x 11	330	0.17	330	270	0.17	330
6.3 x 11	390	0.17	330			
8 x 11.5	680	0.11	580	470	0.11	580
8 x 11.5				560	0.11	580
8 x 15	1000	0.080	750	680	0.080	750
8 x 20	*1 1200	0.060	1000	*1 1000	0.060	1000
8 x 20	*1 1500	0.060	1000			
10 x 12.5	1200	0.063	900	820	0.063	900
10 x 16	1500	0.049	1200	1000	0.049	1200
10 x 16				1200	0.049	1200
10 x 20	2200	0.036	1450	1500	0.036	1450
10 x 22	2700	0.036	1500	1800	0.036	1500
12.5 x 20	3900	0.035	1660	2700	0.035	1660
12.5 x 25	4700	0.027	2000	3900	0.027	2000
12.5 x 25	5600	0.027	2000			
12.5 x 30	*1 6800	0.024	2450	*1 4700	0.024	2450
16 x 21	*2 5600	0.032	2000	*2 3900	0.032	2000
16 x 25	6800	0.022	2560	4700	0.022	2560
16 x 25	8200	0.022	2560	5600	0.022	2560
16 x 31.5	10000	0.017	3010	6800	0.017	3010
16 x 31.5				8200	0.017	3010
16 x 35.5	12000	0.016	3150	10000	0.016	3150
18 x 21	*2 6800	0.030	2490	*2 5600	0.030	2490
18 x 25	*2 10000	0.022	2740	*2 6800	0.022	2740
18 x 30.5	*2 12000	0.017	3330	*2 10000	0.017	3330
18 x 35.5	15000	0.016	3680	12000	0.016	3680

Please refer to page 16 for the ripple current frequency coefficient.

*1 Series code is CXL, *2 Series code is CXS

Size List, Impedance, Rated Ripple Current

Case size φ D x L (mm)	Items	16			25		
		Capacitance (μF)	Impedance (Ωmax) (20°C/100kHz)	Ripple current (mArms) (105°C/10k to 200kHz)	Capacitance (μF)	Impedance (Ωmax) (20°C/100kHz)	Ripple current (mArms) (105°C/10k to 200kHz)
5 x 11		100	0.34	205	68	0.34	205
6.3 x 11		180	0.17	330	120	0.17	330
8 x 11.5		330	0.11	580	220	0.11	580
8 x 15		470	0.080	750	330	0.080	750
8 x 20		680	0.060	1000	470	0.060	1000
10 x 12.5		560	0.063	900	390	0.063	900
10 x 16		820	0.049	1200	560	0.049	1200
10 x 20		1000	0.036	1450	680	0.036	1450
10 x 20					820	0.036	1450
10 x 22		1200	0.036	1500	1000	0.036	1500
12.5 x 20		1500	0.035	1660	1200	0.035	1660
12.5 x 20		1800	0.035	1660			
12.5 x 25		2200	0.027	2000	1800	0.027	2000
12.5 x 25		2700	0.027	2000			
12.5 x 30	※1	3300	0.024	2450	※1 2200	0.024	2450
16 x 21	※2	2700	0.032	2000	※2 1800	0.032	2000
16 x 25		3300	0.022	2560	2700	0.022	2560
16 x 25		3900	0.022	2560			
16 x 31.5		4700	0.017	3010	3300	0.017	3010
16 x 31.5		5600	0.017	3010			
16 x 35.5		6800	0.016	3150	3900	0.016	3150
18 x 21	※2	3300	0.030	2490	※2 2200	0.030	2490
18 x 25	※2	4700	0.022	2740	※2 3300	0.022	2740
18 x 30.5					※2 3900	0.017	3330
18 x 35.5		8200	0.016	3680	5600	0.016	3680

Case size φ D x L (mm)	Items	35		
		Capacitance (μF)	Impedance (Ωmax) (20°C/100kHz)	Ripple current (mArms) (105°C/10k to 200kHz)
5 x 11		47	0.34	205
6.3 x 11		100	0.17	330
8 x 11.5		150	0.11	580
8 x 15		220	0.080	750
8 x 20	※1	330	0.060	1000
10 x 12.5		270	0.063	900
10 x 16		330	0.049	1200
10 x 16		390	0.049	1200
10 x 20		470	0.036	1450
10 x 20		560	0.036	1450
10 x 22		680	0.036	1500
12.5 x 20		820	0.035	1660
12.5 x 25		1200	0.027	2000
12.5 x 30	※1	1500	0.024	2450
16 x 21	※2	1200	0.032	2000
16 x 25		1800	0.022	2560
16 x 31.5		2700	0.017	3010
16 x 35.5		3300	0.016	3150
18 x 21	※2	1500	0.030	2490
18 x 25		2200	0.022	2740
18 x 35.5		3900	0.016	3680

※1 Series code is CXL, ※2 Series code is CXS

Model No.

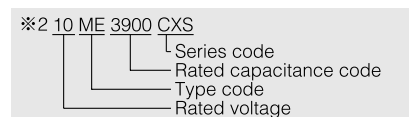
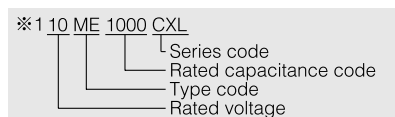
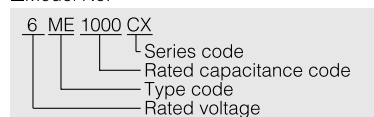

ME-AX Series

Low Impedance

Long Life



- 105°C, 2,500 to 10,000hrs
- Solvent proof (within 5 minutes)

Specifications

Items	Condition	Specifications								
Rated voltage (V)	—	6.3	10	16	25	35	50	63	100	
Surge voltage (V)	Room temperature	8.0	13	20	32	44	63	79	125	
Category temperature range (°C)	—	-55 to +105								-40 to +105
Capacitance tolerance (%)	120Hz/20°C	M : ±20								
Dissipation Factor (DF)	120Hz/20°C	0.22	0.19	0.16	0.14	0.12	0.10	0.10	0.10	
Leakage current (LC)	µA/after 2minutes (max)	The greater value of either 0.01CV or 3								
Impedance ratio at low temperature	Based the value at 120Hz, +20°C	-40°C	Z/Z _{20°C}	3	2	2	2	2	2	2
		-55°C	Z/Z _{20°C}	4	4	3	3	3	2	2
Endurance	105°C rated voltage applied (With the rated ripple current)	Test	φ 5 : 2,500hrs., φ 6.3 : 3,000hrs., φ 8 × 11.5, φ 8 × 12.5 : 3,500hrs., φ 8 × 15, φ 8 × 20 : 4,500hrs., φ 10 : 5,000hrs., φ 12.5 : 7,000hrs., φ 16 to φ 18 : 10,000hrs.							
		ΔC/C	Within ±20% of the initial value							
		tan δ	≤ 2 times the initial specified value							
		LC	≤ The initial specified value							

Dimensions

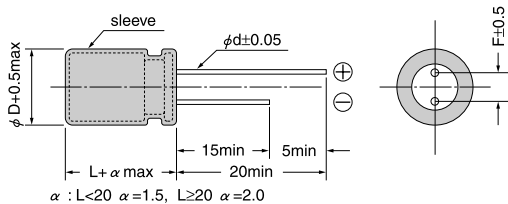

(Unit : mm)

φ D	5	6.3	8	10	12.5	16	18
F	2.0	2.5	3.5	5.0	5.0	7.5	7.5
φ d	0.5	0.5	0.6	0.6	0.6	0.8	0.8

A pressure relief vent is attached to products over φ D=6.3

Size List, Impedance, Rated Ripple Current

V Items Case size φ D x L (mm)	6.3			10		
	Capacitance (µF)	Impedance (Ωmax) (20°C/100kHz)	Ripple current (mA rms) (105°C/10k to 200kHz)	Capacitance (µF)	Impedance (Ωmax) (20°C/100kHz)	Ripple current (mA rms) (105°C/10k to 200kHz)
5 x 11	150	0.42	190	100	0.42	190
6.3 x 11	270	0.22	300	220	0.22	300
8 x 11.5	470	0.11	560	330	0.11	560
8 x 12.5	560	0.11	570	390	0.11	570
8 x 15	680	0.085	730	470	0.085	730
8 x 20	1000	0.069	800	*1 680	0.069	800
10 x 12.5	820	0.085	800	680	0.085	800
10 x 16	1200	0.062	1050	820	0.062	1050
10 x 20	1500	0.044	1250	1200	0.044	1250
10 x 22	1800	0.039	1450	1500	0.039	1450
12.5 x 20	2700	0.038	1600	2200	0.038	1600
12.5 x 25	3900	0.029	1800	2700	0.029	1800
16 x 25	5600	0.022	2100	3900	0.022	2100
16 x 31.5	8200	0.018	2350	5600	0.018	2350
16 x 35	10000	0.018	2550	6800	0.018	2550
18 x 35.5	12000	0.018	2800	8200	0.018	2800

*1 Series code is AXL

Size List, Impedance, Rated Ripple Current

V Items Case size φ D x L (mm)	16			25		
	Capacitance (μF)	Impedance (Ωmax) (20°C/100kHz)	Ripple current (mArms) (105°C/10k to 200kHz)	Capacitance (μF)	Impedance (Ωmax) (20°C/100kHz)	Ripple current (mArms) (105°C/10k to 200kHz)
5 x 11	68	0.42	190	47	0.42	190
6.3 x 11	150	0.22	300	100	0.22	300
8 x 11.5	220	0.11	560	150	0.11	560
8 x 12.5	270	0.11	570	180	0.11	570
8 x 15	330	0.085	730	220	0.085	730
8 x 20	※1 470	0.069	800	330	0.069	800
10 x 12.5	470	0.085	800	270	0.085	800
10 x 16	560	0.062	1050	390	0.062	1050
10 x 20	820	0.044	1250	560	0.044	1250
10 x 22	1000	0.039	1450	680	0.039	1450
12.5 x 20	1200	0.038	1600	1000	0.038	1600
12.5 x 25	1800	0.029	1800	1200	0.029	1800
16 x 25	2700	0.022	2100	1800	0.022	2100
16 x 31.5	3900	0.018	2350	2700	0.018	2350
16 x 35	4700	0.018	2550	3300	0.018	2550
18 x 35.5	5600	0.018	2800	3900	0.018	2800

V Items Case size φ D x L (mm)	35			50		
	Capacitance (μF)	Impedance (Ωmax) (20°C/100kHz)	Ripple current (mArms) (105°C/10k to 200kHz)	Capacitance (μF)	Impedance (Ωmax) (20°C/100kHz)	Ripple current (mArms) (105°C/10k to 200kHz)
5 x 11	4.7	1.2	115	0.47 to 4.7	5.5 to 2.0	20 to 90
5 x 11	10	0.90	140	10	1.7	110
5 x 11	22	0.42	190	15	1.2	130
5 x 11	33	0.42	190	22	0.70	160
6.3 x 11	68	0.22	300	47	0.43	220
8 x 11.5	100	0.11	560	68	0.26	360
8 x 12.5	120	0.11	570	82	0.24	400
8 x 15	150	0.085	730	100	0.18	500
8 x 20	※1 220	0.069	800	150	0.16	650
10 x 12.5	220	0.085	800	120	0.16	550
10 x 16	270	0.062	1050	180	0.12	760
10 x 20	330	0.044	1250	270	0.088	950
10 x 22	470	0.039	1450	330	0.072	1000
12.5 x 20	680	0.038	1600	470	0.059	1200
12.5 x 25	1000	0.029	1800	560	0.045	1400
16 x 25	1500	0.022	2100	1000	0.039	1750
16 x 31.5	2200	0.018	2350	1200	0.025	2100
16 x 35	※1 2200	0.018	2550	1500	0.025	2300
18 x 35.5	2700	0.018	2800	1800	0.024	2400

V Items Case size φ D x L (mm)	63			100		
	Capacitance (μF)	Impedance (Ωmax) (20°C/100kHz)	Ripple current (mArms) (105°C/10k to 200kHz)	Capacitance (μF)	Impedance (Ωmax) (20°C/100kHz)	Ripple current (mArms) (105°C/10k to 200kHz)
5 x 11	18	1.6	140	5.6	2.7	120
6.3 x 11	33	0.90	200	12	1.4	170
8 x 11.5	68	0.52	275	22	0.81	230
8 x 12.5	※1 68	0.47	300	※1 22	0.79	250
8 x 15	82	0.34	360	27	0.64	295
8 x 20	※1 120	0.21	510	※1 39	0.36	400
10 x 12.5	120	0.26	420	39	0.39	360
10 x 16	150	0.20	525	47	0.35	420
10 x 20	220	0.15	765	68	0.24	630
10 x 22	270	0.12	840	82	0.21	700
12.5 x 20	330	0.10	960	100	0.15	800
12.5 x 25	470	0.064	1200	150	0.11	920
16 x 25	680	0.052	1500	220	0.071	1100
16 x 31.5	1000	0.042	1750	330	0.049	1490
16 x 35	1200	0.036	1920	390	0.043	1630
18 x 35.5	1500	0.033	2000	470	0.038	1700

Please refer to page 16 for the ripple current frequency coefficient.

※1 Series code is AXL

Model No.

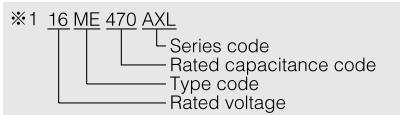
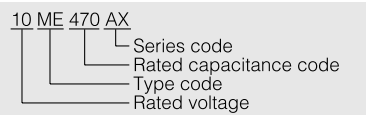

ME-WX Series

Low Impedance

High Ripple Current

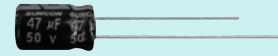

- 105°C, 2,000 to 5,000hrs
- Do not clean the capacitors using solvent.

Specifications

Items	Condition	Specifications						
Rated voltage (V)	—	6.3	10	16	25	35	50	
Surge voltage (V)	Room temperature	8.0	13	20	32	44	63	
Category temperature range (°C)	—	-40 to +105						
Capacitance tolerance (%)	120Hz/20°C	M : ±20						
Dissipation Factor (DF)	120Hz/20°C	0.22	0.19	0.16	0.14	0.12	0.10	
		When rated capacitance exceeds 1,000 μF, add 0.02 to the value above for each 1,000 μF increase.						
Leakage current (LC)	μA/after 2minutes (max)	0.01CV						
Impedance ratio at low temperature	Based the value at 120Hz, +20°C	-25°C Z/Z _{20°C}	2	2	2	2	2	2
		-40°C Z/Z _{20°C}	3	3	3	3	3	3
Endurance	105°C rated voltage applied (With the rated ripple current)	Test	φ 5 to φ 6.3 : 2,000hrs., φ 8 : 3,000hrs., φ 10 to φ 12.5 : 4,000hrs., φ 16 : 5,000hrs.					
		ΔC/C	Within ±25% of the initial value					
		tan δ	≤ 2 times the initial specified value					
		LC	≤ The initial specified value					

Dimensions

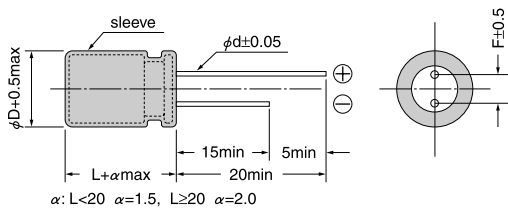

(Unit : mm)

φ D	5	6.3	8	10	12.5	16
F	2.0	2.5	3.5	5.0	5.0	7.5
φ d	0.5	0.5	0.6	0.6	0.6※	0.8

※ φ 12.5 x 30 : φ d=0.8

A pressure relief vent is attached to products over φ D=6.3

Size List, Impedance, Rated Ripple Current

Case size φ D x L (mm)	Items	6.3			10		
		Capacitance (μF)	Impedance and ESR (Ωmax) (20°C/100kHz)	Ripple current (mA rms) (105°C/100kHz)	Capacitance (μF)	Impedance and ESR (Ωmax) (20°C/100kHz)	Ripple current (mA rms) (105°C/100kHz)
5 x 11		150	0.30	250	100	0.30	250
6.3 x 11		330	0.13	405	220	0.13	405
8 x 11.5		560	0.072	760	470	0.072	760
8 x 15		820	0.056	995	※1 680	0.056	995
8 x 20	※1	1200	0.041	1250	※1 1000	0.041	1250
10 x 12.5		1000	0.053	1030	680	0.053	1030
10 x 16		1200	0.038	1430	1000	0.038	1430
10 x 20		1500	0.023	1820	1200	0.023	1820
10 x 20		2200	0.023	1820	1500	0.023	1820
10 x 23	※3	2200	0.022	2150	※3 1500	0.022	2150
12.5 x 20		3300	0.021	2360	2200	0.021	2360
12.5 x 25		3900	0.018	2770	3300	0.018	2770
12.5 x 30		4700	0.016	3290	3900	0.016	3290
16 x 21		5600	0.018	3140	※2 3900	0.018	3140
16 x 25		6800	0.016	3460	5600	0.016	3460

※1 Series code is WXL

※2 Series code is WXS

※3 Series code is WXV

Size List, Impedance, Rated Ripple Current

Case size # D x L (mm)	Items V	16			25		
		Capacitance	Impedance and ESR (Ω_{max})	Ripple current (mArms)	Capacitance	Impedance and ESR (Ω_{max})	Ripple current (mArms)
		(μF)	(20°C/100kHz)	(105°C/100kHz)	(μF)	(20°C/100kHz)	(105°C/100kHz)
5 x 11		56	0.30	250	47	0.30	250
6.3 x 11		120	0.13	405	100	0.13	405
8 x 11.5		330	0.072	760	220	0.072	760
8 x 15	※1	470	0.056	995	330	0.056	995
8 x 20	※1	680	0.041	1250	※1 470	0.041	1250
10 x 12.5		470	0.053	1030	※2 330	0.053	1030
10 x 16		680	0.038	1430	470	0.038	1430
10 x 20		1000	0.023	1820	680	0.023	1820
10 x 20		1200	0.023	1820	820	0.023	1820
10 x 23	※3	1200	0.022	2150	※3 820	0.022	2150
12.5 x 20		1500	0.021	2360	1000	0.021	2360
12.5 x 25		2200	0.018	2770	1500	0.018	2770
12.5 x 30		2700	0.016	3290	1800	0.016	3290
16 x 21	※2	2700	0.018	3140	※2 1800	0.018	3140
16 x 25		3900	0.016	3460	2700	0.016	3460

Case size # D x L (mm)	Items V	35			50		
		Capacitance	Impedance and ESR (Ω_{max})	Ripple current (mArms)	Capacitance	Impedance and ESR (Ω_{max})	Ripple current (mArms)
		(μF)	(20°C/100kHz)	(105°C/100kHz)	(μF)	(20°C/100kHz)	(105°C/100kHz)
5 x 11		33	0.30	250	22	0.34	238
6.3 x 11		56	0.13	405	47	0.14	385
8 x 12.5	※3	150	0.072	760	100	0.074	724
8 x 15		220	0.056	995	120	0.061	950
8 x 20	※1	270	0.041	1250	180	0.046	1190
10 x 12.5	※2	220	0.053	1030	150	0.061	979
10 x 16		330	0.038	1430	220	0.042	1370
10 x 20		470	0.023	1820	270	0.030	1580
10 x 23	※3	560	0.022	2150	330	0.028	1870
12.5 x 20		680	0.021	2360	470	0.027	2050
12.5 x 25		1000	0.018	2770	560	0.023	2410
12.5 x 30		1200	0.016	3290	680	0.021	2860
16 x 21	※2	1200	0.018	3140	820	0.023	2730
16 x 25		1800	0.016	3460	1000	0.021	3010

Please refer to page 16 for the ripple current frequency coefficient.

- ※1 Series code is WXL
- ※2 Series code is WXS
- ※3 Series code is WXV

Model No.

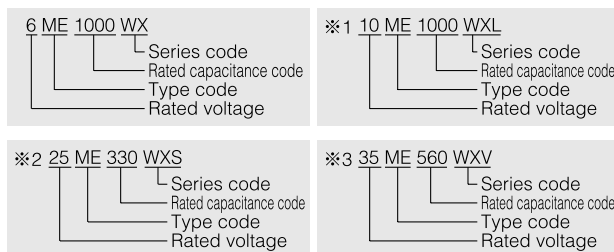

ME-WA Series

105°C, Miniature, Long Life

Low Impedance, High Ripple Current



- 105°C, 8,000 to 10,000hrs
- Do not clean the capacitors using solvent.

Specifications

Items	Condition	Specifications				
		6.3	10	16	25	35
Rated voltage (V)	—	6.3	10	16	25	35
Surge voltage (V)	Room temperature	8.0	13	20	32	44
Category temperature range (°C)	—	-40 to +105				
Capacitance tolerance (%)	120Hz/20°C	M : ±20				
Dissipation Factor (DF)	120Hz/20°C	0.22	0.19	0.16	0.14	0.12
		When rated capacitance exceeds 1,000 μF, add 0.02 to the value above for each 1,000 μF increase.				
Leakage current (LC)	μA/after 2minutes (max)	0.03CV				
Impedance ratio at low temperature	Based the value at 120Hz, +20°C	-25°C Z/Z _{20°C}	2	2	2	2
		-40°C Z/Z _{20°C}	3	3	3	3
Endurance	105°C rated voltage applied (With the rated ripple current)	Test	φ 8 : 8,000hrs., φ 10 to φ 16 : 10,000hrs.			
		ΔC/C	Within ±25% of the initial value (6.3V, 10V : ±30%)			
		tan δ	≤ 2 times the initial specified value			
		LC	≤ The initial specified value			

Dimensions

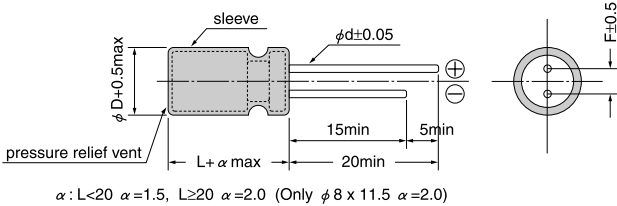

(Unit : mm)

φ D	8	10	12.5	16
F	3.5	5.0	5.0	7.5
φ d	0.6	0.6	0.6*	0.8

* φ 12.5 x 30 : φ d = 0.8

Size List, Impedance, Rated Ripple Current

Case size φ D x L (mm)	Items	6.3			10		
		Capacitance (μF)	Impedance (Ωmax) (20°C/100kHz)	Ripple current (mA rms) (105°C/100kHz)	Capacitance (μF)	Impedance (Ωmax) (20°C/100kHz)	Ripple current (mA rms) (105°C/100kHz)
8 x 11.5		820	0.059	945	680	0.059	945
8 x 15	*1	1200	0.046	1250	*1 1000	0.046	1250
8 x 20		1500	0.031	1500	*1 1500	0.031	1500
10 x 12.5		1200	0.043	1330	1000	0.043	1330
10 x 16		1800	0.030	1760	1500	0.030	1760
10 x 20		2200	0.021	1960	1800	0.021	1960
10 x 22		2700	0.020	2250	2200	0.020	2250
12.5 x 20		3900	0.019	2480	3300	0.019	2480
12.5 x 25		4700	0.016	2900	3900	0.016	2900
12.5 x 30		5600	0.014	3450	*1 4700	0.014	3450
16 x 21		6800	0.018	3250	4700	0.018	3250
16 x 25		8200	0.014	3630	6800	0.014	3630

*1 Series code is WAL

Size List, Impedance, Rated Ripple Current

Case size φ D x L (mm)	Items	16			25		
		Capacitance	Impedance (Ωmax)	Ripple current (mArms)	Capacitance	Impedance (Ωmax)	Ripple current (mArms)
		(μF)	(20°C/100kHz)	(105°C/100kHz)	(μF)	(20°C/100kHz)	(105°C/100kHz)
8 x 11.5		470	0.059	945	330	0.059	945
8 x 15	※1	680	0.046	1250	390	0.046	1250
8 x 20	※1	1000	0.031	1500	560	0.031	1500
10 x 12.5		680	0.043	1330	470	0.043	1330
10 x 16		1000	0.030	1760	680	0.030	1760
10 x 20		1500	0.021	1960	820	0.021	1960
10 x 22		1800	0.020	2250	1000	0.020	2250
12.5 x 20		2200	0.019	2480	1500	0.019	2480
12.5 x 25		2700	0.016	2900	1800	0.016	2900
12.5 x 30	※1	3300	0.014	3450	※1 2200	0.014	3450
16 x 21		3300	0.018	3250	2200	0.018	3250
16 x 25		4700	0.014	3630	3300	0.014	3630

Case size φ D x L (mm)	Items	35		
		Capacitance	Impedance (Ωmax)	Ripple current (mArms)
		(μF)	(20°C/100kHz)	(105°C/100kHz)
8 x 11.5		220	0.059	945
8 x 15		270	0.046	1250
8 x 20		390	0.031	1500
10 x 12.5		330	0.043	1330
10 x 16		470	0.030	1760
10 x 20		560	0.021	1960
10 x 22		680	0.020	2250
12.5 x 20		1000	0.019	2480
12.5 x 25		1200	0.016	2900
12.5 x 30	※1	1500	0.014	3450
16 x 21		1500	0.018	3250
16 x 25		2200	0.014	3630

Please refer to page 16 for the ripple current frequency coefficient.

※1 Series code is WAL

Model No.

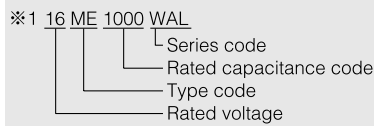
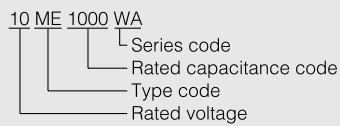

ME-WL Series

105°C, Miniature, Low Impedance

Long Life



- 105°C, 4,000 to 5,000hrs
- Do not clean the capacitors using solvent.

Specifications

Items	Condition	Specifications								
Rated voltage (V)	—	6.3	10	16	25	35	50	63		
Surge voltage (V)	Room temperature	8.0	13	20	32	44	63	79		
Category temperature range (°C)	—	-40 to +105								
Capacitance tolerance (%)	120Hz/20°C	M : ±20								
Dissipation Factor (DF)	120Hz/20°C	0.22	0.19	0.16	0.14	0.12	0.10	0.10		
Leakage current (LC)	μA/after 2minutes (max)	The greater value of either 0.01CV or 3								
Impedance ratio at low temperature	Based the value at 120Hz, +20°C	-25°C Z/Z _{20°C}	4	3	2	2	2	2	2	
		-40°C Z/Z _{20°C}	8	6	4	3	3	3	3	
Endurance	105°C, rated voltage applied (With the rated ripple current)	test	4,000hrs.		5,000hrs.					
		ΔC/C	Within ±25% of the initial value							
		tan δ	≤ 2 times the initial specified value							
		LC	≤ The initial specified value							

Dimensions

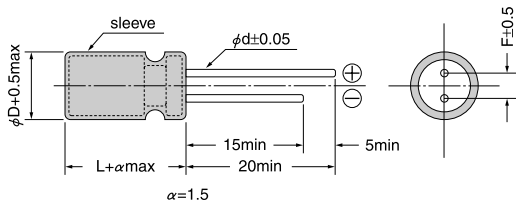

(Unit : mm)

φ D	5	6.3
F	2.0	2.5
φ d	0.5	0.5

A pressure relief vent is attached to products φD=6.3

Size List, Impedance, Rated Ripple Current

V	6.3	10	16	25	35	50	63
1.0						5×11 4.80 30	
2.2						5×11 3.00 43	
3.3						5×11 2.64 53	
4.7						5×11 2.28 88	
10						5×11 1.80 100	
15							5×11 1.06 165
22						5×11 0.84 180	
33					5×11 0.69 210		6.3×11 0.42 265
47				5×11 0.69 210		6.3×11 0.40 250	
56			5×11 0.69 210		6.3×11 0.26 340	6.3×11 0.36 295	
100		5×11 0.69 210		6.3×11 0.26 340			
120			6.3×11 0.26 340				
150	5×11 0.69 210						
220		6.3×11 0.26 340					
330	6.3×11 0.26 340						

Please refer to page 16 for the ripple current frequency coefficient.

Case size : φ D × L (mm)

Rated ripple current
mA_{rms} (100kHz, 105°C)

Impedance (Ω)
max at 100kHz, 20°C

Model No. 16 ME 120 WL
 — Series code
 — Rated capacitance code
 — Type code
 — Rated voltage

MB-UWG Series

Low ESR, High Ripple Current

5mm Height

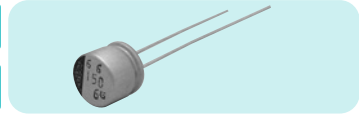

- 105°C, 1,000hrs
- Laminated aluminum case
- Do not clean the capacitors using solvent.

Specifications

Items	Condition	Specifications				
Rated voltage (V)	—	6.3	10	16	25	
Surge voltage (V)	Room temperature	8.0	13	20	32	
Category temperature range (°C)	—	-40 to +105				
Capacitance tolerance (%)	120Hz/20°C	M : ±20				
Dissipation Factor (DF)	120Hz/20°C	0.24	0.20	0.16	0.14	
Leakage current (LC)	μA/after 2minutes (max)	0.03CV				
Impedance ratio at low temperature	Based the value at 120Hz, +20°C	-25°C / Z/Z _{20°C}	2	2	2	2
		-40°C / Z/Z _{20°C}	3	3	3	3
Endurance	105°C, 1,000hrs. rated voltage applied (With the rated ripple current)	ΔC/C	Within ±25% of the initial value (6.3V, 10V : ±30%)			
		tan δ	≤ 2 times the initial specified value			
		LC	≤ The initial specified value			

Marking, Dimensions

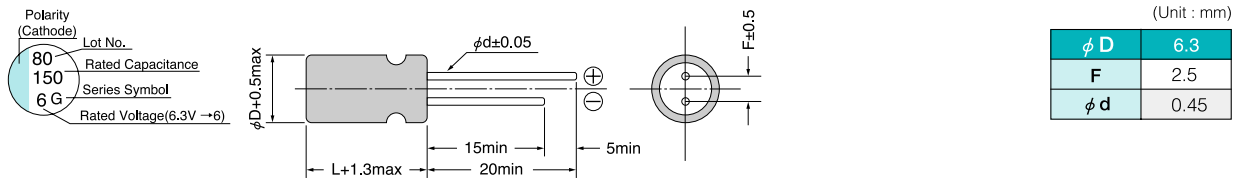

Size List, ESR, Rated Ripple Current

V Items	6.3			10			16			25		
	Case size φ D x L (mm)	ESR (Ωmax) 20°C/100kHz	Ripple current (mA rms) 105°C/100kHz	Case size φ D x L (mm)	ESR (Ωmax) 20°C/100kHz	Ripple current (mA rms) 105°C/100kHz	Case size φ D x L (mm)	ESR (Ωmax) 20°C/100kHz	Ripple current (mA rms) 105°C/100kHz	Case size φ D x L (mm)	ESR (Ωmax) 20°C/100kHz	Ripple current (mA rms) 105°C/100kHz
39										6.3 x 5	0.14	360
68							6.3 x 5	0.14	360			
100				6.3 x 5	0.14	360						
150	6.3 x 5	0.14	360									

Please refer to page 16 for the ripple current frequency coefficient.

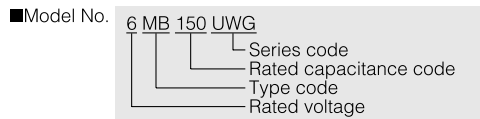

ME-SWG Series

Low ESR, Miniature

7mm Height



- 105°C, 1,000 to 2,000hrs
- Do not clean the capacitors using solvent.

Specifications

Items	Condition	Specifications					
Rated voltage (V)	—	6.3	10	16	25	35	
Surge voltage (V)	Room temperature	8.0	13	20	32	44	
Category temperature range (°C)	—	-40 to +105					
Capacitance tolerance (%)	120Hz/20°C	M : ±20					
Dissipation Factor (DF)	120Hz/20°C	0.24	0.20	0.16	0.14	0.12	
Leakage current (LC)	µA/after 2minutes (max)	0.03CV					
Impedance ratio at low temperature	Based the value at 120Hz, +20°C	-25°C Z/Z _{20°C}	2	2	2	2	2
		-40°C Z/Z _{20°C}	3	3	3	3	3
Endurance	105°C rated voltage applied (With the rated ripple current)	Test	φ 5 : 1,000hrs., φ 6.3 : 2,000hrs., (6ME330SWG, 10ME220SWG : 1,000hrs.)				
		ΔC/C	Within ±25% of the initial value (6.3V, 10V : ±30%)				
		tan δ	≤ 2 times the initial specified value				
		LC	≤ The initial specified value				

Dimensions

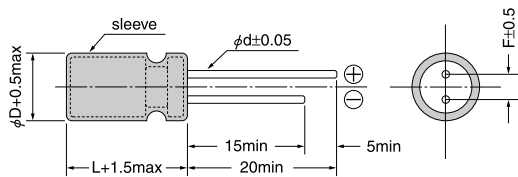

(Unit : mm)

φ D	5	6.3
F	2.0	2.5
φ d	0.45	0.45

Size List, ESR, Rated Ripple Current

V Items µF	6.3			10			16			25			35		
	Case size φ D x L (mm)	ESR (Ωmax) 20°C/100kHz	Ripple current (mA _{RMS}) 105°C/100kHz	Case size φ D x L (mm)	ESR (Ωmax) 20°C/100kHz	Ripple current (mA _{RMS}) 105°C/100kHz	Case size φ D x L (mm)	ESR (Ωmax) 20°C/100kHz	Ripple current (mA _{RMS}) 105°C/100kHz	Case size φ D x L (mm)	ESR (Ωmax) 20°C/100kHz	Ripple current (mA _{RMS}) 105°C/100kHz	Case size φ D x L (mm)	ESR (Ωmax) 20°C/100kHz	Ripple current (mA _{RMS}) 105°C/100kHz
22										5 x 7	0.17	390	5 x 7	0.17	390
39							5 x 7	0.17	390	5 x 7	0.17	390			
47													6.3 x 7	0.082	760
56				5 x 7	0.17	390									
100	5 x 7	0.17	390	6.3 x 7	0.082	760	6.3 x 7	0.082	760	6.3 x 7	0.082	760			
150	6.3 x 7	0.082	760	6.3 x 7	0.082	760	6.3 x 7	0.082	760						
220	6.3 x 7	0.082	760	6.3 x 7	0.082	760									
330	6.3 x 7	0.082	760												

Please refer to page 16 for the ripple current frequency coefficient.

Model No.

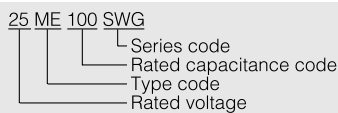

ME-WG Series

Low ESR, Miniature



- 105°C, 2,000 to 4,000hrs
- Do not clean the capacitors using solvent.

Specifications

Items	Condition	Specifications				
Rated voltage (V)	—	6.3	10	16	25	
Surge voltage (V)	Room temperature	8.0	13	20	32	
Category temperature range (°C)	—	-40 to +105				
Capacitance tolerance (%)	120Hz/20°C	M : ±20				
Dissipation Factor (DF)	120Hz/20°C	0.22	0.19	0.16	0.14	
		When rated capacitance exceeds 1,000 μF, add 0.02 to the value above for each 1,000 μF increase.				
Leakage current (LC)	μA/after 2minutes (max)	0.03CV				
Impedance ratio at low temperature	Based the value at 120Hz, +20°C	-25°C Z/Z _{20°C}	2	2	2	2
		-40°C Z/Z _{20°C}	3	3	3	3
Endurance	105°C rated voltage applied (With the rated ripple current)	Test	φ8×11.5, φ8×16, φ10×12.5, φ10×16 : 2,000hrs., φ8×20 : 3,000hrs., φ10×20, φ10×23 : 4,000hrs.			
		ΔC/C	Within ±25% of the initial value			
		tan δ	≤ 2 times the initial specified value			
		LC	≤ The initial specified value			

Dimensions

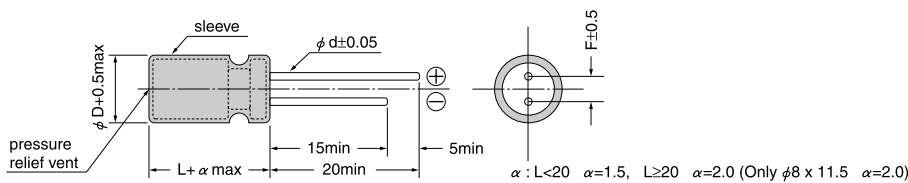

(Unit : mm)

φ D	8	10
F	3.5	5.0
φ d	0.6	0.6

Size List, ESR, Rated Ripple Current

V Items μF	6.3			10			16			25		
	Case size φ D x L (mm)	ESR (mΩmax) 20°C/100kHz	Ripple current (mA rms) 105°C/100kHz	Case size φ D x L (mm)	ESR (mΩmax) 20°C/100kHz	Ripple current (mA rms) 105°C/100kHz	Case size φ D x L (mm)	ESR (mΩmax) 20°C/100kHz	Ripple current (mA rms) 105°C/100kHz	Case size φ D x L (mm)	ESR (mΩmax) 20°C/100kHz	Ripple current (mA rms) 105°C/100kHz
220												
330							8 x 11.5	30	1140	8 x 11.5	30	1110
470				8 x 11.5	30	1140	8 x 11.5	36	1140	8 x 20 ※1	18	1820
680				8 x 11.5	36	1140	8 x 16 ※1	28	1490	10 x 12.5	27	1390
820	8 x 11.5	36	1140				10 x 12.5	26	1540	10 x 16 ※3	20	1920
1000	8 x 11.5	30	1140	8 x 16 ※1	28	1490	8 x 20 ※1	19	1870	10 x 20 ※3	16	2180
1200	8 x 16	28	1490	10 x 12.5	26	1540	10 x 16	19	2000	10 x 23 ※1	16	2180
1500	8 x 20 ※1	19	1870	8 x 20 ※1	19	1870	10 x 20	13	2550			
	8 x 20 ※2	16	1950	10 x 16	19	2000						
	10 x 12.5	26	1540									
	10 x 16 ※3	18	2000									
1800	8 x 20 ※2	16	1950	10 x 20	13	2550	10 x 23	12	2800			
	10 x 16	19	2000									
2200	10 x 20	13	2550	10 x 23	12	2800						
3300	10 x 23	12	2800									

Please refer to page 16 for the ripple current frequency coefficient.

- ※1 Series code is WGL
- ※2 Series code is WGL2
- ※3 Series code is WGV

Model No.

10 ME 1000 WG

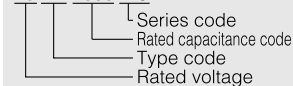

※1 6 ME 1500 WGL

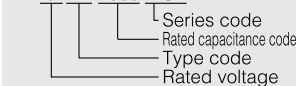

※2 6 ME 1500 WGL2

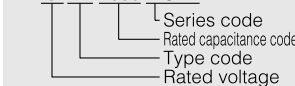

※3 25 ME 470 WG

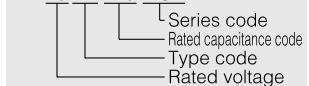

ME-PX Series

125°C, 4,000Hrs.

High Performance

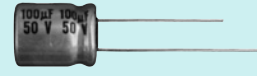

- 125°C, 2,000 to 4,000hrs
- Solvent proof (within 5 minutes)

Specifications

Items	Condition	Specifications						
Rated voltage (V)	—	10	16	25	35	50	100	
Surge voltage (V)	Room temperature	13	20	32	44	63	125	
Category temperature range (°C)	—	-55 to +125						
Capacitance tolerance (%)	120Hz/20°C	M : ±20						
Dissipation Factor (DF)	120Hz/20°C	0.20	0.16	0.14	0.12	0.10	0.08	
		When rated capacitance exceeds 1,000 µF, add 0.02 to the value above for each 1,000 µF increase.						
Leakage current (LC)	µA/after 2minutes (max)	The greater value of either 0.01CV or 3						
Impedance ratio at low temperature	Based the value at 120Hz, +20°C	-40°C Z/Z _{20°C}	2	2	2	2	2	2
		-55°C Z/Z _{20°C}	4	3	3	3	2	2
Endurance	125°C rated voltage applied (With the rated ripple current)	Test	φ 8 : 2,000hrs., φ 10 : 3,000hrs., φ 12.5 to φ 18 : 4,000hrs.					
		△C/C	Within ±30% of the initial value					
		tan δ	≤ 3 times the initial specified value					
		LC	≤ The initial specified value					

Dimensions

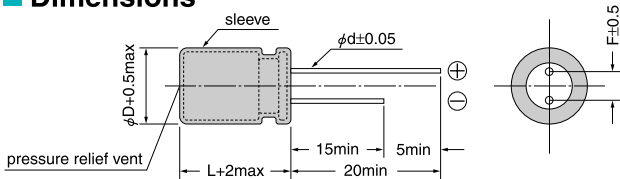

(Unit : mm)

φ D	8	10	12.5	16	18
F	3.5	5.0	5.0	7.5	7.5
φ d	0.6	0.6	0.6	0.8	0.8

Size List, Impedance, Rated Ripple Current

µF \ V	10	16	25	35	50	100
1.0					8x11.5, 2.0, 28	
2.2					8x11.5, 1.8, 42	
3.3					8x11.5, 1.5, 49	
4.7					8x11.5, 1.15, 70	8x11.5, 2.0, 100
10					8x11.5, 0.95, 150	8x11.5, 1.5, 150
22					8x11.5, 0.65, 210	8x12.5, 1.5, 190
33					8x12.5, 0.45, 230	10x12.5, 0.75, 330
47				8x12.5, 0.45, 230	8x12.5, 0.45, 230	10x16, 0.57, 400
100		8x11.5, 0.39, 250	8x12.5, 0.26, 280	10x12.5, 0.35, 315	10x12.5, 0.35, 315	12.5x20, 0.29, 580
220	8x12.5, 0.26, 280	10x12.5, 0.20, 350	10x12.5, 0.17, 380	10x16, 0.29, 420	10x20, 0.20, 560	16x25, 0.22, 670
330	10x12.5, 0.20, 350	10x12.5, 0.17, 380	10x16, 0.15, 490	10x20, 0.20, 560	12.5x20, 0.12, 630	16x31.5, 0.15, 810
470	10x12.5, 0.17, 380	10x16, 0.15, 490	10x20, 0.12, 590	12.5x20, 0.12, 630	12.5x25, 0.10, 770	18x31.5, 0.11, 950
1000	10x20, 0.12, 590	12.5x20, 0.073, 770	12.5x25, 0.050, 1050	16x25, 0.058, 980	16x31.5, 0.045, 1200	
2200	12.5x25, 0.050, 1050	16x25, 0.044, 1150	16x31.5, 0.030, 1500			
3300	16x25, 0.044, 1150	16x31.5, 0.030, 1500				
4700	16x31.5, 0.030, 1500					

Please refer to page 16 for the ripple current frequency coefficient.

Case size : φ D x L (mm)

Rated ripple current
mA Arms (10k to 100kHz, 125°C)

Impedance (Ω)
max at 100kHz, 20°C

Model No.

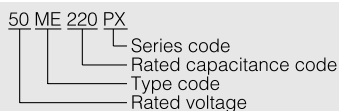

ME-PX Series

125°C

Mid. and High Voltage



- 125°C, 2,000hrs
- Do not clean the capacitors using solvent.

Specifications

Items	Condition	Specifications						
Rated voltage (V)	—	160	200	250	350	400		
Surge voltage (V)	Room temperature	200	250	300	400	450		
Category temperature range (°C)	—	-40 to +125			-25 to +125			
Capacitance tolerance (%)	120Hz/20°C	M : ±20						
Dissipation Factor (DF)	120Hz/20°C	0.20	0.20	0.20	0.24	0.24		
Leakage current (LC)	µA/after 2minutes (max)	0.02CV + 25						
Impedance ratio at low temperature	Based the value at 120Hz, +20°C	-25°C	Z/Z _{20°C}	3	3	3	6	6
		-40°C	Z/Z _{20°C}	6	6	6	—	—
Endurance	125°C, 2,000hrs. rated voltage applied (With the rated ripple current)	ΔC/C	Within ±20% of the initial value					
		tan δ	≤ 2 times the initial specified value					
		LC	≤ The initial specified value					

Dimensions

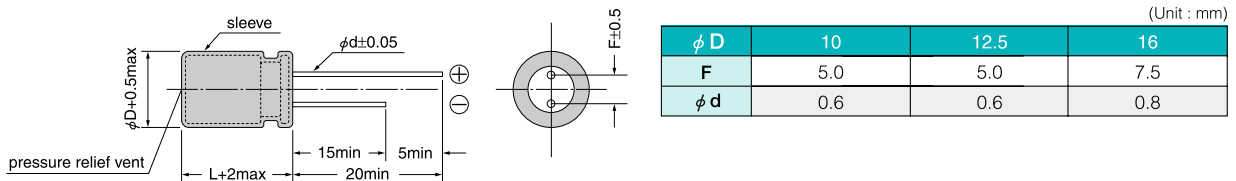

Size List, Rated Ripple Current

µF \ V	160	200	250	350	400					
4.7										
10		10 x 20	78	10 x 20	78					
22	10 x 20	115	10 x 20	95	12.5 x 20	78	10 x 20	67	12.5 x 20	86
33	10 x 20	125	12.5 x 20	157	12.5 x 25	171	12.5 x 25	139	12.5 x 25	142
47	12.5 x 20	187	12.5 x 25	204	16 x 25	225	16 x 25	189	16 x 25	189
68	12.5 x 20	200	16 x 21	250	16 x 31.5	292	16 x 31.5	243	16 x 31.5	243
100	16 x 25	329								
150	16 x 31.5	434								

Please refer to page 16 for the ripple current frequency coefficient.

Case size ; φ D x L (mm)

Rated ripple current
mA_{rms} (120Hz, 125°C)

Model No.

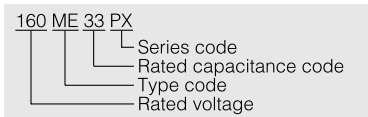

ME-FC-FD Series

105°C Miniature, Mid. and High Voltage

105°C Low Profile, Mid. and High Voltage

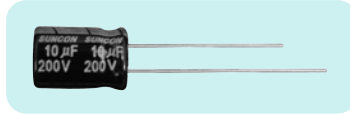

- 105°C, 1,000 to 2,000hrs
- Do not clean the capacitors using solvent.

Specifications

Items	Condition	Specifications						
Rated voltage (V)	—	160	200	250	350	400	450	
Surge voltage (V)	Room temperature	200	250	300	400	450	500	
Category temperature range (°C)	—	-40 to +105						
Capacitance tolerance (%)	120Hz/20°C	M : ±20						
Dissipation Factor (DF)	120Hz/20°C	0.20	0.20	0.20	0.25	0.25	0.25	
Leakage current (LC)	µ A/after 2minutes (max)	CV ≤ 1,000	0.03CV + 15					
		CV > 1,000	0.02CV + 25					
Impedance ratio at low temperature	Based the value at 120Hz, +20°C	-25°C Z/Z _{20°C}	3	3	3	4	6	6
		-40°C Z/Z _{20°C}	6	6	6	8	10	—
Endurance	105°C rated voltage applied (With the rated ripple current)	Test	φ 5 to φ 8 : 1,000hrs., φ 10 to φ 18 : 2,000hrs.					
		△C/C	Within ±20% of the initial value					
		tan δ	≤ 2 times the initial specified value					
		LC	≤ The initial specified value					

Dimensions

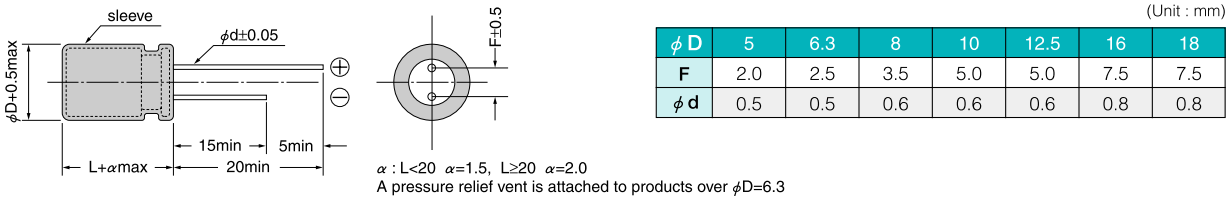

Size List, Rated Ripple Current

µF	V	160	200	250	350	400	450					
0.47	5 x 11	7	5 x 11	8	5 x 11	8	6.3 x 11	10	6.3 x 11	10		
1.0	5 x 11	15	5 x 11	16	5 x 11	18	6.3 x 11	20	8 x 11.5	20	8 x 12.5	18
2.2	6.3 x 11	22	6.3 x 11	24	6.3 x 11	25	8 x 11.5	28	8 x 11.5	28	10 x 16	28
3.3	6.3 x 11	28	6.3 x 11	32	8 x 11.5	34	8 x 12.5	36	10 x 12.5	36	10 x 20	36
4.7	6.3 x 11	39	8 x 11.5	40	8 x 11.5	41	10 x 12.5	47	10 x 16	47	12.5 x 20	47
10	8 x 11.5	63	8 x 12.5	64	10 x 12.5	66	10 x 20	70	10 x 20	70	12.5 x 25 16 x 21	70
22	10 x 12.5	107	10 x 16	112	10 x 20	119	12.5 x 25 16 x 21	123	12.5 x 25 16 x 21	126	16 x 25 18 x 21	125
33	10 x 20	137	10 x 20	147	12.5 x 20	154	16 x 25 18 x 21	158	16 x 25 18 x 21	161	16 x 30 18 x 25	154
47	12.5 x 20	172	12.5 x 20	175	12.5 x 25 16 x 21	182	16 x 30 18 x 25	182	16 x 30 18 x 25	189	18 x 35.5	172
68	12.5 x 20	217	12.5 x 25 16 x 21	228	16 x 25 18 x 21	235	16 x 35.5 18 x 30.5	242	18 x 35.5	249		
82	12.5 x 25 16 x 21	270	16 x 21	277	16 x 30 18 x 25	284	18 x 35.5	294				
100	12.5 x 25 16 x 21	287	16 x 25 18 x 21	301	16 x 35.5 18 x 25	302						
150	16 x 30 18 x 25	385	16 x 35.5 18 x 30.5	403	18 x 35.5	412						
220	16 x 35.5 18 x 30.5	522	18 x 35.5	532								

Upper ; FC series (0.47µF to 4.7µF ; FC series)
Lower ; FD series

Please refer to page 16 for the ripple current frequency coefficient.

Rated ripple current
mA rms (120Hz, 105°C)

Model No.

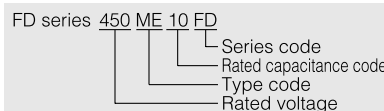
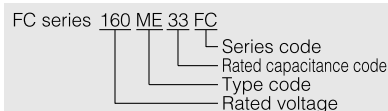

Case size ; φ D x L (mm)

ME-FAZ Series

Low Impedance

High Ripple, Mid. Voltage



- 105°C, 1,000 to 2,000hrs
- Do not clean the capacitors using solvent.

Specifications

Items	Condition	Specifications				
Rated voltage (V)	—	160	180	200	250	
Surge voltage (V)	Room temperature	200	225	250	300	
Category temperature range (°C)	—	-40 to +105				
Capacitance tolerance (%)	120Hz/20°C	M : ±20				
Dissipation Factor (DF)	120Hz/20°C	0.10	0.10	0.10	0.10	
Leakage current (LC)	µ A/after 2minutes (max)	CV ≤ 1,000	0.03CV + 15			
		CV > 1,000	0.02CV + 25			
Impedance ratio at low temperature	Based the value at 120Hz, +20°C	-25°C Z/Z _{20°C}	3	3	3	3
		-40°C Z/Z _{20°C}	5	5	5	5
Endurance	105°C rated voltage applied (With the rated ripple current)	Test	φ 8 : 1,000hrs., φ 10 to φ 18 : 2,000hrs.			
		△C/C	Within ±20% of the initial value			
		tan δ	≤ 2 times the initial specified value			
		LC	≤ The initial specified value			

Dimensions

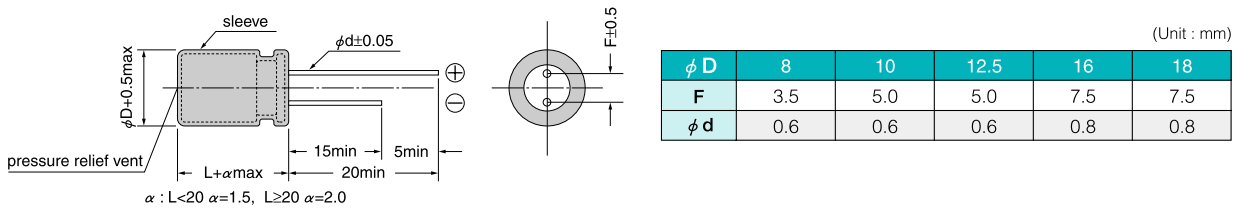

Size List, Impedance, Rated Ripple Current

µF \ V	160			180			200			250		
1.0							8 x 11.5	6.30	56	8 x 11.5	4.83	64
2.2							8 x 11.5	4.65	79	8 x 11.5	3.93	86
3.3	8 x 11.5	3.12	106	8 x 11.5	3.12	106	8 x 11.5	3.12	106	8 x 11.5	3.29	116
4.7	8 x 11.5	2.58	117	8 x 11.5	2.58	117	8 x 12.5	1.65	151	10 x 12.5	1.89	160
10	8 x 12.5	2.05	212	8 x 12.5	2.05	212	10 x 12.5	1.24	233	10 x 16	1.32	253
22	10 x 16	0.96	389	10 x 16	0.96	389	10 x 20	0.85	423	12.5 x 20	0.58	440
33	10 x 20	0.54	515	10 x 20	0.54	515	12.5 x 20	0.50	530	12.5 x 25	0.54	546
47	12.5 x 20	0.41	638	12.5 x 20	0.41	638	12.5 x 25	0.38	659	16 x 25	0.39	665
100	16 x 25	0.24	728	16 x 25	0.24	728	16 x 30	0.17	740	16 x 35.5	0.17	751
150	16 x 30	0.13	844	16 x 35.5	0.12	892	18 x 35.5	0.12	917	18 x 35.5	0.12	955
220	16 x 35.5	0.11	1113	18 x 35.5	0.10	1134						

Please refer to page 16 for the ripple current frequency coefficient.

Model No.

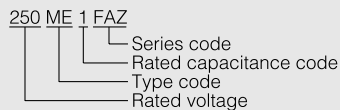

Case size ; φ D x L (mm)

Rated ripple current
mA rms (100kHz, 105°C)

Impedance (Ω)
max at 100kHz, 20°C

ME-FH Series

105°C, Miniature, Long Life

Mid. and High Voltage



- 105°C, 10,000hrs
- Do not clean the capacitors using solvent.

Specifications

Items	Condition	Specifications						
Rated voltage (V)	—	160	200	250	350	400	450	
Surge voltage (V)	Room temperature	200	250	300	400	450	500	
Category temperature range (°C)	—	-40 to +105						
Capacitance tolerance (%)	120Hz/20°C	M : ±20						
Dissipation Factor (DF)	120Hz/20°C	0.20	0.20	0.20	0.25	0.25	0.25	
Leakage current (LC)	μA/after 2minutes (max)	0.02CV + 25						
Impedance ratio at low temperature	Based the value at 120Hz, +20°C	-25°C Z/Z _{20°C}	3	3	3	4	6	6
		-40°C Z/Z _{20°C}	6	6	6	8	10	—
Endurance	105°C, 10,000hrs. rated voltage applied (With the rated ripple current)	ΔC/C	Within ±20% of the initial value					
		tan δ	≤ 2 times the initial specified value					
		LC	≤ The initial specified value					

Dimensions

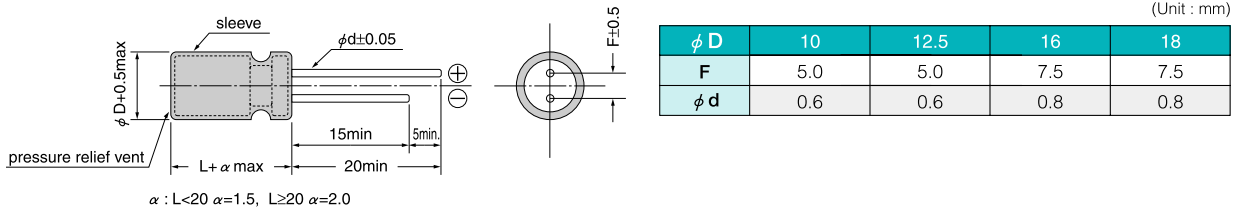

Size List, Rated Ripple Current

μF \ V	160	200	250	350	400	450
6.8						10 x 20 58
10			10 x 16 106	10 x 16 100	10 x 20 108	12.5 x 20 145
22		10 x 16 173	10 x 20 184	12.5 x 20 184	12.5 x 25 195	16 x 25 218
33	10 x 16 190	10 x 20 227	12.5 x 20 238	12.5 x 25 224	16 x 25 249	16 x 31.5 243
47	10 x 20 270	12.5 x 20 270	12.5 x 25 282	16 x 25 282	16 x 31.5 292	18 x 31.5 304
68	12.5 x 20 336	12.5 x 20 325	16 x 25 364	16 x 31.5 334	18 x 31.5 346	
82	12.5 x 20 346	12.5 x 25 370	16 x 25 403	18 x 31.5 360		
100	12.5 x 25 410	16 x 25 436	16 x 31.5 418			
150	16 x 25 500	16 x 31.5 470	18 x 31.5 545			
220	16 x 31.5 570	18 x 31.5 660				

Please refer to page 16 for the ripple current frequency coefficient.

Model No.

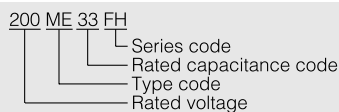

Case size : φ D x L (mm)

Rated ripple current mArms (120Hz, 105°C)

ME-SWN Series

Bi-polar

7mm Height



- 85°C, 1,000hrs
- Solvent proof (within 3 minutes)

Specifications

Items	Condition	Specifications					
Rated voltage (V)	—	6.3	10	16	25	35	50
Surge voltage (V)	Room temperature	8.0	13	20	32	44	63
Category temperature range (°C)	—	-40 to +85					
Capacitance tolerance (%)	120Hz/20°C	M : ±20					
Dissipation Factor (DF)	120Hz/20°C	0.24	0.22	0.20	0.18	0.16	0.16
Leakage current (LC)	μ A/after 1minute (max)	0.03CV + 6					
Endurance	500hrs. X 2 (alternately) 85°C, rated voltage applied (With the rated ripple current)	ΔC/C	Within ±25% of the initial value				
		tan δ	≤ 2 times the initial specified value				
		LC	≤ The initial specified value				

Dimensions

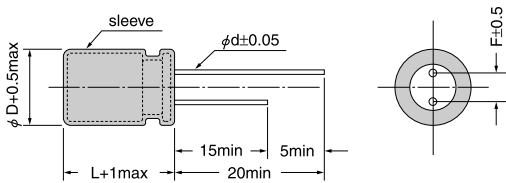

(Unit : mm)

φ D	4	5	6.3
F	1.5	2.0	2.5
φ d	0.45	0.45	0.45

Size List, Rated Ripple Current

μF \ V	6.3		10		16		25		35		50	
0.10											4 x 7	1.0
0.22											4 x 7	2.3
0.33											4 x 7	3.5
0.47											4 x 7	5.0
1.0											4 x 7	10
2.2									4 x 7	10	5 x 7	15
3.3							4 x 7	16	5 x 7	17	5 x 7	18
4.7							4 x 7	19	5 x 7	20	6.3 x 7	23
10			4 x 7	17	4 x 7	25	5 x 7	28	6.3 x 7	30	6.3 x 7	34
22	5 x 7	31	5 x 7	35	6.3 x 7	39	6.3 x 7	52				
33	5 x 7	39	6.3 x 7	43	6.3 x 7	57						
47	6.3 x 7	47	6.3 x 7	59	6.3 x 7	68						

Please refer to page 16 for the ripple current frequency coefficient.

Rated ripple current
mA rms (120Hz, 85°C)

Model No.

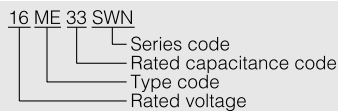

Case size ; φ D x L (mm)

ME-HWN Series

Bi-polar

Standard

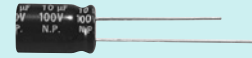

- 85°C, 2,000hrs
- Solvent proof (within 5 minutes)

Specifications

Items	Condition	Specifications							
Rated voltage (V)	—	6.3	10	16	25	35	50	100	
Surge voltage (V)	Room temperature	8.0	13	20	32	44	63	125	
Category temperature range (°C)	—	-40 to +85							
Capacitance tolerance (%)	120Hz/20°C	M : ±20							
Dissipation Factor (DF)	120Hz/20°C	0.24	0.20	0.18	0.16	0.14	0.13	0.10	
		When rated capacitance exceeds 1,000 μF, add 0.02 to the value above for each 1,000 μF increase.							
Leakage current (LC)	μA/after 1minute (max)	0.03CV + 6							
Impedance ratio at low temperature	Based the value at 120Hz, +20°C	-25°C Z/Z _{20°C}	4	3	3	2	2	2	2
		-40°C Z/Z _{20°C}	10	8	8	6	4	4	4
Endurance	500hrs. X 4 (alternately) 85°C, rated voltage applied (With the rated ripple current)	ΔC/C	Within ±25% of the initial value						
		tan δ	≤ 2 times the initial specified value						
		LC	≤ The initial specified value						

Dimensions

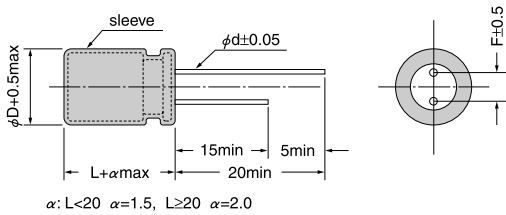

(Unit : mm)

φ D	5	6.3	8	10	12.5
F	2.0	2.5	3.5	5.0	5.0
φ d	0.5	0.5	0.6	0.6	0.6

A pressure relief vent is attached to products over φ D=6.3

Size List, Rated Ripple Current

μF \ V	6.3	10	16	25	35	50	100
0.47						5 x 11	5.0 5 x 11 8.0
1.0						5 x 11	10 5 x 11 15
2.2						5 x 11	20 5 x 11 25
3.3						5 x 11	28 6.3 x 11 30
4.7				5 x 11	25	5 x 11	30 5 x 11 38 6.3 x 11 45
10			5 x 11	28	5 x 11	40	5 x 11 45 6.3 x 11 50 8 x 12.5 70
22		5 x 11	38	5 x 11	50	5 x 11	60 6.3 x 11 75 6.3 x 11 90 10 x 16 120
33	5 x 11	50	5 x 11	58	5 x 11	60	6.3 x 11 80 6.3 x 11 90 8 x 11.5 110 10 x 20 170
47	5 x 11	60	5 x 11	70	6.3 x 11	85	6.3 x 11 90 8 x 11.5 125 10 x 12.5 135 12.5 x 20 200
100	6.3 x 11	120	6.3 x 11	125	8 x 11.5	165	8 x 12.5 180 10 x 12.5 200 10 x 20 250
220	8 x 11.5	210	8 x 12.5	225	10 x 12.5	260	10 x 16 320 10 x 20 350 12.5 x 25 410
330	8 x 11.5	260	10 x 12.5	295	10 x 16	360	10 x 20 425 12.5 x 20 440
470	10 x 12.5	330	10 x 16	390	10 x 20	420	12.5 x 20 540 12.5 x 25 585
1000	10 x 20	560	12.5 x 20	620	12.5 x 25	740	
2200	12.5 x 25	890					

Please refer to page 16 for the ripple current frequency coefficient.

Rated ripple current
mA Arms (120Hz, 85°C)

Case size ; φ D x L (mm)

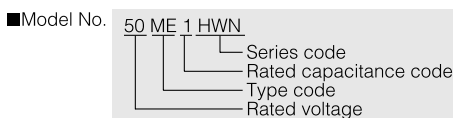

EP-cap



EP-cap are electrolytic capacitors with hybrid cathode electrolyte. High conductive electrolyte (solid conductive polymer) is combined. EP-cap have very low ESR at high frequency as compared with electrolytic capacitors. The structure of hybrid cathode electrolyte enables EP-cap to have the same self-healing function as aluminum electrolytic capacitors. EP-cap have hi-reliability product of 125 degrees Celsius (HVP series) and high voltage up to 63V.

Basic Construction

EP-cap

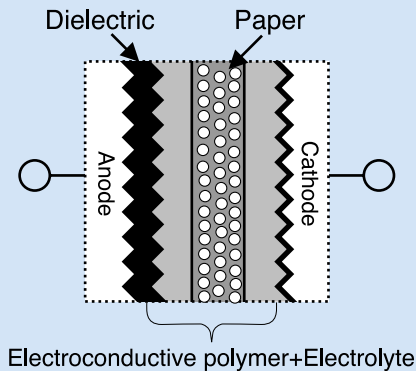

Electrolytic Capacitor

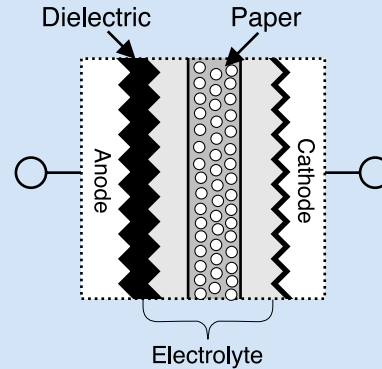

Features

1. Super low ESR (Downsize and upgrade your circuit)
 - Excellent noise absorption capability at high frequency.
 - High ripple current. Suitable for smoothing circuit of switching regulator.
2. Excellent low temperature characteristics (Stable performance at low temperature range)
3. Self-healing property of liquid electrolyte
(Compared to solid capacitors, short circuit mode seldom happen and L.C. is lower.)
4. Rated voltage is up to 63V.
5. Applying a voltage up to the rated voltage is guaranteed. (Voltage derating is not needed)
6. RoHS compliance and lead-free (Environmental friendly)

Applications

· Automotive electric · Network · Industrial · Flat-TV (LCD, PDP etc.) · PC (Server etc.) · Power supply (Inverter etc.)

Product Line-up Table

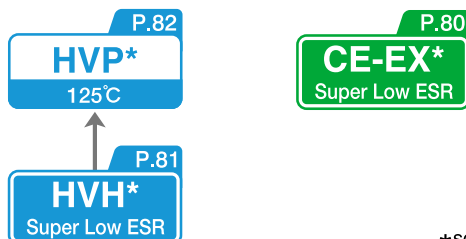

*solvent proof

INDEX

- About EP-cap
 - Soldering Condition / Recommended Reflow Condition / Ripple Current Frequency Coefficient 79
- Hybrid Conductive Polymer Type
 - Surface Mount Type
 - CE-EX Series 80
 - HVH Series 81
 - HVP Series 82

Soldering Condition

- Soldering with a soldering iron - within 350°C ×3 seconds unless otherwise specified in the spec.
- Thermal curing over - ambient temperature within 150°C ×2 minutes.

Recommended Reflow Condition

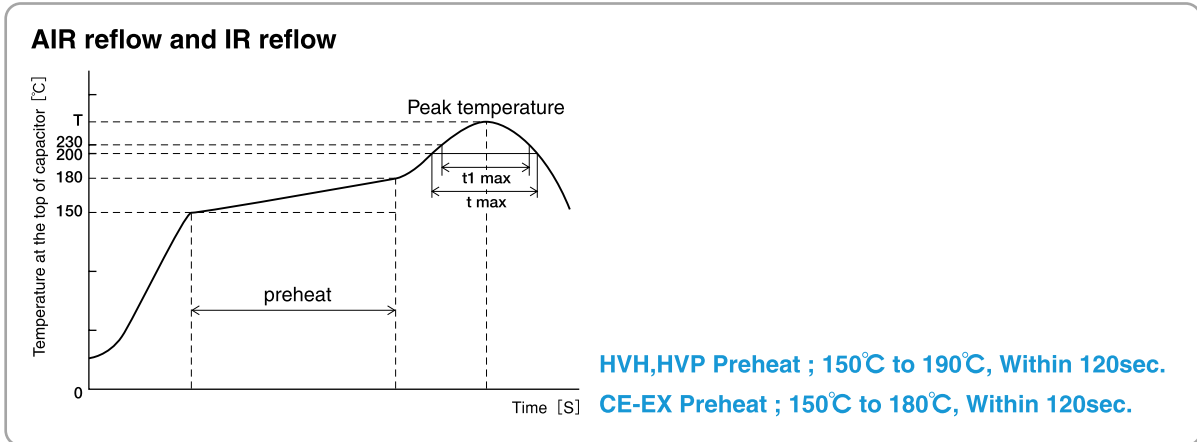

Series	Voltage	Size	Time for more than 200°C (t)	Time for more than 230°C (t1)	Peak temperature (Within 5sec.)
HVH,HVP	ALL	φ 6.3 to φ 10	Within 80sec.	Within 40sec.	260°C
CE-EX	ALL	φ 6.3	Within 70sec.	Within 40sec.	250°C
		φ 8	Within 60sec.	Within 30sec.	245°C
		φ 10	Within 50sec.	Within 20sec.	240°C

Capacitors can withstand two reflow processes on the above conditions. Second reflow shall be taken after more than one hour natural cooling time and taken after the return to normal temperatures of PCB board and components.

Ripple Current Frequency Coefficient

Series	Capacitance:C(μF)	Frequency:F(Hz)			
		100≤F<1k	1k≤F<10k	10k≤F<100k	100k≤F<500k
HVH HVP	C ≤ 4.7	0.03	0.30	0.65	1.00
	4.7 < C ≤ 33	0.05	0.32	0.67	1.00
	33 < C	0.10	0.35	0.70	1.00
CE-EX	C ≤ 33	0.05	0.32	0.65	1.00
	33 < C	0.10	0.35	0.65	1.00

Anti-vibration structure

Available for φ8 and φ10.

[Type code]

Standard structure	Anti-vibration structure
CE	CA
HV	HA

CE-EX Series

Low ESR at High Frequency



- 105°C, 2,000 to 3,000hrs
- Solvent proof (within 2 minutes)

Specifications

Items	Condition	Specifications		
Rated voltage (V)	—	4.0	6.3	10
Surge voltage (V)	Room temperature	4.6	7.2	11.5
Category temperature range (°C)	—	-55 to +105		
Capacitance tolerance (%)	120Hz/20°C	M : ±20		
Dissipation Factor (DF)	120Hz/20°C	0.24	0.22	0.20
Leakage current (LC)	μA/after 2minutes (max)	The greater value of either 0.1CV or 50		
Temperature characteristics Impedance ratio	Based the value at 120Hz, +20°C	-55°C	Z/Z _{20°C}	
		105°C	Z/Z _{20°C}	
Endurance	105°C rated voltage applied (With the rated ripple current)	Test	φ 6.3 : 2,000hrs., φ 8 to φ 10 : 3,000hrs. (4V : 2,000hrs.)	
		ΔC/C	Within ±30% of the initial value	
		tan δ	≤ 2 times the initial specified value	
		LC	≤ The initial specified value	

Marking, Dimensions

Polarity (Cathode)

Lot No.

80
47
10E

Rated Capacitance

Series Symbol

Rated Voltage(6.3V→6)

(Unit : mm)

D ^{+0.5max}	L ^{+0.3}	W ^{+0.2}	H ^{+0.2}	C ^{+0.2}	R	P ^{+0.2}
6.3	6.0	6.6	6.6	7.3	0.5 to 0.8	2.2
8	10.5	8.3	8.3	9.0	0.7 to 1.0	3.2
10	10.5	10.3	10.3	11.0	1.0 to 1.4	4.6

A pressure relief vent is attached to products over φ D=8

Size List, ESR, Rated Ripple Current

μF	4.0			6.3			10			
	V	Case size	ESR (mΩ)	V	Case size	ESR (mΩ)	V	Case size	ESR (mΩ)	
22								6.3 x 6.0	60	1020
33								6.3 x 6.0	60	1020
47								6.3 x 6.0	60	1020
100				6.3 x 6.0	50	1120		8 x 10.5	30	1550
150								8 x 10.5	30	1550
220				8 x 10.5	30	1550		8 x 10.5	30	1550
330				8 x 10.5	30	1550		10 x 10.5	25	2090
390				8 x 10.5	30	1550		10 x 10.5	25	2090
470	8 x 10.5	30	1550	10 x 10.5	25	2090				
560				10 x 10.5	25	2090				
680	10 x 10.5	25	2090							
820	10 x 10.5	23	2180							

Please refer to page 79 for the ripple current frequency coefficient.

ESR (mΩ)
max at 100kHz, 20°C

Rated ripple current
mA_{rms} (100kHz, 105°C)

Case size ; φ D x L (mm)

Model No.

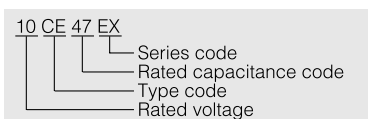

HVH Series

Super Low ESR

High Voltage, Long Life



- 105°C, 5,000 to 10,000hrs
- Solvent proof (within 2 minutes)

Specifications

Items	Condition	Specifications			
Rated voltage (V)	—	25	35	50	63
Surge voltage (V)	Room temperature	32	44	63	79
Category temperature range (°C)	—	-55 to +105			
Capacitance tolerance (%)	120Hz/20°C	M : ±20			
Dissipation Factor (DF)	120Hz/20°C	0.16			
Leakage current (LC)	μA/after 2minutes (max)	The greater value of either 0.05CV or 100			
Temperature characteristics Impedance ratio	Based the value at 120Hz, +20°C	-55°C Z/Z _{20°C}	1 to 2.5		
		105°C Z/Z _{20°C}	0.6 to 1.0		
Endurance	105°C rated voltage applied (With the rated ripple current)	Test	φ 8 to φ 10 : 10,000hrs. (25V : 7,000hrs.) , φ 6.3 : 5,000hrs.		
		ΔC/C	Within ±30% of the initial value		
		tan δ	≤ 2 times the initial specified value		
		ESR	≤ 2 times the initial specified value		
		LC	≤ The initial specified value		

Marking, Dimensions

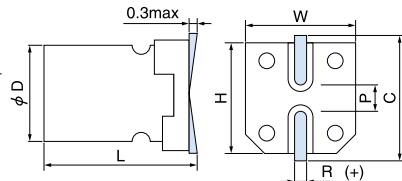
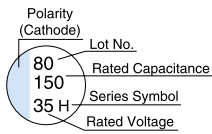

(Unit : mm)

D ^{+0.5max}	L ^{+0.3}	W ^{+0.2}	H ^{+0.2}	C ^{+0.2}	R	P ^{+0.2}
6.3	6.0	6.6	6.6	7.3	0.5 to 0.8	2.2
6.3	7.7	6.6	6.6	7.3	0.5 to 0.8	2.2
8	10.5	8.3	8.3	9.0	0.7 to 1.0	3.2
10	10.5	10.3	10.3	11.0	1.0 to 1.4	4.6

A pressure relief vent is attached to products over φD=8

Size List, ESR, Rated Ripple Current

μF \ V	25		35		50		63				
2.7							6.3 x 6.0	150	960		
3.9							6.3 x 7.7	100	1060		
5.6					6.3 x 6.0	120	980				
10					6.3 x 7.7	80	1200				
22							8 x 10.5	40	1560		
27			6.3 x 6.0	100	1080						
33						8 x 10.5	35	1670	10 x 10.5	30	2100
47	6.3 x 6.0	60	1270	6.3 x 7.7	60	1300					
56							10 x 10.5	25	2320		
68	6.3 x 7.7	45	1400								
100				8 x 10.5	30	1800					
150	8 x 10.5	27	1900	10 x 10.5	23	2470					
270	10 x 10.5	22	2530								

Please refer to page 79 for the ripple current frequency coefficient.

Case size ; φ D x L (mm)

Rated ripple current
mArms (100kHz, 105°C)

ESR (mΩ)
max at 100kHz, 20°C

Model No.

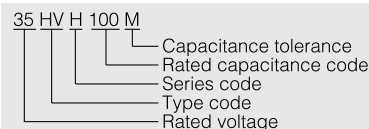

HVP Series

125°C Super Low ESR

High Voltage, High Reliability



- 125°C, 1,500 to 3,000hrs
- Solvent proof (within 2 minutes)

Specifications

Items	Condition	Specifications			
Rated voltage (V)	—	25	35	50	63
Surge voltage (V)	Room temperature	32	44	63	79
Category temperature range (°C)	—	-55 to +125			
Capacitance tolerance (%)	120Hz/20°C	M : ±20			
Dissipation Factor (DF)	120Hz/20°C	0.16			
Leakage current (LC)	μA/after 2minutes (max)	The greater value of either 0.05CV or 100			
Temperature characteristics Impedance ratio	Based the value at 120Hz, +20°C	-55°C	Z/Z _{20°C}	1 to 2.5	
		125°C	Z/Z _{20°C}	0.6 to 1.0	
Endurance	125°C rated voltage applied (With the rated ripple current)	Test	φ 8 to φ 10 : 3,000hrs. (25V : 2,500hrs.) , φ 6.3 : 2,000hrs. (25V : 1,500hrs.)		
		ΔC/C	Within ±30% of the initial value		
		tan δ	≤ 2 times the initial specified value		
		ESR	≤ 2 times the initial specified value		
		LC	≤ The initial specified value		

Marking, Dimensions

Polarity (Cathode)

Lot No.

80 Rated Capacitance

150 Series Symbol

35 P Rated Voltage

(Unit : mm)

D ^{+0.5max}	L ^{+0.3}	W ^{+0.2}	H ^{+0.2}	C ^{+0.2}	R	P ^{+0.2}
6.3	7.7	6.6	6.6	7.3	0.5 to 0.8	2.2
8	10.5	8.3	8.3	9.0	0.7 to 1.0	3.2
10	10.5	10.3	10.3	11.0	1.0 to 1.4	4.6

A pressure relief vent is attached to products over φ D=8

Size List, ESR, Rated Ripple Current

μF	V	25		35		50		63			
		Case	ESR	Case	ESR	Case	ESR	Case	ESR		
3.9								6.3 x 7.7	100	740	
10						6.3 x 7.7	80	840			
22								8 x 10.5	40	1090	
33						8 x 10.5	35	1170	10 x 10.5	30	1260
47				6.3 x 7.7	60	910					
56						10 x 10.5	25	1390			
68	6.3 x 7.7	45	980								
100				8 x 10.5	30	1260					
150	8 x 10.5	27	1330	10 x 10.5	23	1480					
270	10 x 10.5	22	1520								

Please refer to page 79 for the ripple current frequency coefficient.

Case size ; φ D x L (mm)

Rated ripple current
mArms (100kHz, 125°C)

ESR (mΩ)
max at 100kHz, 20°C

Model No.

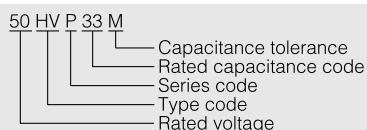



SUN Electronic Industries Corporation

■ Head office

1-1-18, Okayama-higashi, Shijyonawate-City, Osaka, Japan, 575-8585

Phone:81-72-876-1421 FAX:81-72-879-0395

<http://www.sunelec.co.jp>

■ Kanto office

2-22-12, Minami-urawa, Minaimi-ku, Saitama-City, Saitama, Japan, 336-0017

Phone:81-48-881-5711 FAX:81-48-881-5715

■ Suncon Electronics(H.K.) Co., Ltd.

Room2305, 23/F Paul Y. Centre, 51 Hung to Road, Kwun Tong, Kowloon, Hong Kong

Phone:852-2707-0502 FAX:852-2707-9881